

Model GX10/GX20/GP10/GP20

# Paperless Recorder First Step Guide



## Contents

Introduction .....	1	<b>Basic Operation .....</b>	<b>39</b>
Handling Precautions of the GX/GP .....	6	Turning the Power On and Off .....	39
SD Memory Card Handling Precautions .....	6	Setting and Removing SD Memory Cards .....	40
Checking the Package Contents .....	6	Viewing the Operation Screen (Trend).....	40
Standard Accessories .....	9	Displaying the Menu Screen .....	41
Conventions Used in This Manual .....	10	Setting the Date and Time* .....	41
Protection of Environment.....	11	Configuring the Inputs .....	42
<b>Functional Overview .....</b>	<b>12</b>	Starting Measurement and Recording .....	42
Overview .....	12	Switching between Operation Screens .....	42
A Variety of Source Signals .....	12	Saving Data to USB Memory .....	43
Expandable Module Construction .....	12	Switching the Quick Settings (GP only).....	43
GX60 Connection and Multichannel Measurement .....	12	<b>Advanced Operation (Various settings and operation) 44</b>	
High-speed Measurement, Dual Interval Measurement (Measurement mode).....	13	Setting Measurement and Recording Conditions .....	44
Loop Control and Program Control Function (/PG Option).....	13	Setting Alarms .....	44
Data Storage .....	13	Alarm DO output.....	45
A Variety of Display Functions .....	13	Using the Scaling Function (Measuring a flow meter).....	45
Touch Screen .....	14	Using the Scaling Function (Measuring a temperature) .....	46
Freehand Messages .....	14	Registering and Deleting Favorite Screens .....	46
Versatile Network Functions and Software .....	14	<b>Setting the Measurement Mode .....</b>	<b>47</b>
Other Functions .....	15	Setting the Measurement Mode .....	47
System Configuration .....	16	Limitations.....	47
<b>Component Names .....</b>	<b>17</b>	<b>Reconfiguring the GX/GP (Module identification) .....</b>	<b>48</b>
GX20/GX10 .....	17	Reconfiguring the GX/GP.....	48
GP20/GP10 .....	18	Initializing the GX/GP	
GX60/GX90EX.....	18	(Initializing all settings) .....	48
GX90XA/GX90XD/GX90YD/GX90WD/GX90XP/GX90YA/GX90UT	19	<b>Saving and Loading Setting Parameters.....</b>	<b>49</b>
<b>Operating Procedure.....</b>	<b>22</b>	Saving Setting Parameters.....	49
<b>Installation and Wiring.....</b>	<b>24</b>	Loading Setup Parameters .....	49
Installation Location.....	24	<b>Web Application .....</b>	<b>50</b>
Installation Procedure.....	25	Starting the Web Application .....	50
External Dimensions and Panel Cut Dimensions.....	25	Closing the Web Application .....	50
Connect an GX60 .....	28	<b>Application Software.....</b>	<b>51</b>
Installing and Removing I/O Modules .....	29	PC System Requirements.....	51
Wiring.....	30	Installation.....	51
		Starting and Closing Universal Viewer .....	52
		Starting and Closing Hardware Configurator.....	52
		<b>Setup Menu Map.....</b>	<b>53</b>



# User Registration

Thank you for purchasing YOKOGAWA products.

We invite you to register your products in order to receive the most up to date product information. To register, visit the following URL.

***<http://www.yokogawa.com/ns/reg/>***



## Introduction

Thank you for purchasing the SMARTDAC+ GX/GP Series Paperless Recorder (hereafter referred to as the GX/GP). This manual explains the **basic operation, installation, and wiring** of the GX/GP.

For details on **configuring** and **operating** the GX/GP, see the “ Paperless Recorder User’s Manual (IM 04L51B01-01EN) “ provided in electronic format.

For details on the settings and operation of the PID control module and program control (/PG option), see the Loop Control Function, Program Control Function (/PG Option) User’s Manual (IM 04L51B01-31EN), provided as an electronic manual.

This manual supports the following products.

Model	Product Name
GX10/GX20	Paperless Recorder (panel mount type)
GP10/GP20	Paperless recorder (portable type)
GX60	I/O Base Unit (Expandable I/O)

**Although the display of GX20 is used in this guide, GX10/GP10/GP20 can be operated similarly.**

This manual denotes devices with their product names or model (e.g. GX60).

To ensure correct use, please read this manual and the following manuals thoroughly before beginning operation. For a detailed description of the product, see the electronic manual.

For specifications, refer to General Specifications.

## Paper Manuals

Manual Title	Manual No.
Models GX10/GX20/GP10/GP20 Paperless Recorder First Step Guide	IM 04L51B01-02EN (This manual)
Precaution on the use of SMARTDAC+ (Only delivered with each module or GX60)	IM 04L51B01-91EN

## Electronic Manuals

You can download these manuals from the following web page:

[www.smartdacplus.com/manual/en/](http://www.smartdacplus.com/manual/en/)

Manual Title	Manual No.
Model GX10/GX20/GP10/GP20 Paperless Recorder First Step Guide	IM 04L51B01-02EN
<b>Model GX10/GX20/GP10/GP20 Paperless Recorder User’s Manual</b>	<b>IM 04L51B01-01EN</b>
Model GX10/GX20/GP10/GP20/GM10 Communication Command User’s Manual	IM 04L51B01-17EN
SMARTDAC+ STANDARD Universal Viewer User’s Manual	IM 04L61B01-01EN
SMARTDAC+ STANDARD Hardware Configurator User’s Manual	IM 04L61B01-02EN
Model GX10/GX20/GP10/GP20/GM10 Multi-batch Function (/BT) User’s Manual	IM 04L51B01-03EN
Model GX10/GX20/GP10/GP20 Advanced Security Function (/AS) User’s Manual	IM 04L51B01-05EN
Model GX10/GX20/GP10/GP20/GM10 EtherNet/IP Communication (/E1) User’s Manual	IM 04L51B01-18EN
Model GX10/GX20/GP10/GP20/GM10 WT Communication (/E2) User’s Manual	IM 04L51B01-19EN
Model GX10/GX20/GP10/GP20/GM10 OPC-UA Server (/E3) User’s Manual	IM 04L51B01-20EN
Model GX10/GX20/GP10/GP20/GM10 SLMP Communication (/E4) User’s Manual	IM 04L51B01-21EN
Model GX10/GX20/GP10/GP20/GM10 LOG scale (/LG) User’s Manual	IM 04L51B01-06EN
Model GX10/GX20/GP10/GP20/GM10 Loop Control Function, Program Control Function (/PG Option) User’s Manual	IM 04L51B01-31EN
DXA170 DAQStudio User’s Manual	IM 04L41B01-62EN
Precaution on the use of SMARTDAC+	IM 04L51B01-91EN

## General Specifications

Title	General specifications No.
GX10/GX20 Paperless Recorder (panel mount type)	GS 04L51B01-01EN
GP10/GP20 Paperless Recorder (portable type)	GS 04L52B01-01EN
GX60 I/O Base Unit (Expandable I/O) / GX90EX Expansion Module	GS 04L53B00-01EN
GX90XA/GX90XD/GX90YD/GX90WD/GX90XP/GX90YA I/O modules	GS 04L53B01-01EN
GX90UT PID Control Module	GS 04L53B01-31EN
GX10/GX20/GP10/GP20 Paperless Recorder Data Acquisition System GM Loop Control Function, Program Control Function (/PG Option)	

- \* The last two characters of the manual number and general specification number indicate the language in which the manual is written.

## QR Code

The product has a QR Code pasted for efficient plant maintenance work and asset information management. It enables confirming the specifications of purchased products and user’s manuals.

For more details, please refer to the following URL.  
<https://www.yokogawa.com/qr-code>

QR Code is a registered trademark of DENSO WAVE INCORPORATED.

## Notes

- The contents of this manual are subject to change without prior notice as a result of continuing improvements to the instrument’s performance and functions.
- Every effort has been made in the preparation of this manual to ensure the accuracy of its contents. However, should you have any questions or find any errors, please contact your nearest Yokogawa dealer.
- Copying or reproducing all or any part of the contents of this manual without the permission of Yokogawa is strictly prohibited.

## Authorised Representative in the EEA

The Authorised Representative for this product in the EEA is: Yokogawa Europe B.V.

Euroweg 2, 3825 HD Amersfoort, The Netherlands

## Revisions

December 2012	1st Edition	March 2019	11th Edition
February 2013	2nd Edition		
May 2013	3rd Edition		
May 2014	4th Edition		
December 2014	5th Edition		
December 2015	6th Edition		
June 2017	7th Edition		
November 2017	8th Edition		
June 2018	9th Edition		
July 2018	10th Edition		

---

## Trademarks

- SMARTDAC+ and SMARTDACPLUS are registered trademarks of Yokogawa Electric Corporation.
- Microsoft and Windows are registered trademarks or trademarks of Microsoft Corporation in the United States and/or other countries.
- Pentium is a trademark of Intel Corporation in the United States and/or other countries.
- Adobe and Acrobat are registered trademarks or trademarks of Adobe Systems Incorporated.
- Kerberos is a trademark of Massachusetts Institute of Technology (MIT).
- The SD logo is a registered trademark of the SD association.
- Company and product names that appear in this manual are registered trademarks or trademarks of their respective holders.
- The company and product names used in this manual are not accompanied by the registered trademark or trademark symbols (® and ™).

## Manual guide for various items and functions

Item, Function	Main manual Document name No.	Related manuals		
		User's Manual IM 04L51B01-01EN	Communication Command User's Manual IM 04L51B01-17EN	Paperless Recorder First Step Guide IM 04L51B01-02EN
		Standard settings,operation	Communication comand	Installation and Wiring
Safety Precautions, Installation and Wiring, Basic operation of the GX/GP	First Step Guide IM 04L51B01-02EN		✓	
basic operation and setting of the GX/GP.	User's Manual IM 04L51B01-01EN		✓	
Math function (/MT)	User's Manual IM 04L51B01-01EN		✓	
Report function (/MT)	User's Manual IM 04L51B01-01EN		✓	
Report Template Function (/MT)	User's Manual IM 04L51B01-01EN		✓	
Batch Function	User's Manual IM 04L51B01-01EN		✓	
Modbus Function	User's Manual IM 04L51B01-01EN		✓	
DARWIN compatible communication function	User's Manual IM 04L51B01-01EN		✓	
Communication channel function (/MC)	User's Manual IM 04L51B01-01EN		✓	
Serial communication function (/C2, /C3)	User's Manual IM 04L51B01-01EN		✓	✓
Advanced security function (Part 11)	Advanced Security Function (/AS) User's Manual IM 04L51B01-05EN	✓	✓	
EtherNet/IP Communication (/E1)	EtherNet/IP Communication (/E1) User's Manual IM 04L51B01-18EN	✓	✓	
WT Communication (/E2)	WT Communication (/E2) User's Manual IM 04L51B01-19EN		✓	
Aerospace heat treatment (/AH)	User's Manual IM 04L51B01-01EN		✓	
Multi Batch Function (/BT)	Multi Batch Function (/BT) User's Manual IM 04L51B01-03EN	✓	✓	
OPC-UA Server (/E3)	OPC-UA Server (/E3) User's Manual IM 04L51B01-20EN	✓	✓	
SLMP Communication (/E4)	SLMP Communication (/E4) User's Manual IM 04L51B01-21EN	✓	✓	
Custom Display (/CG option)	DXA170 DAQStudio IM 04L41B01-62EN	✓	✓	
Log Scale (/LG)	Log Scale (/LG) User's Manual IM 04L51B01-06EN	✓	✓	
Loop Control Function, Program Control Function (/PG)	Loop Control Function, Program Control Function (/PG Option) User's Manual IM 04L51B01-31EN	✓	✓	✓

## Safety Precautions

- This instrument conforms to IEC safety class I (provided with terminal for protective grounding), Overvoltage Category II or I, and EN61326-1 (EMC standard), Measurement Category II (CAT II).\*
  - \* Measurement Category II (CAT II) are for the analog input modules (GX90XA) and PID control module (GX90UT).  
Measurement category II (CAT II) applies to measuring circuits connected to low voltage installation, and electrical instruments supplied with power from fixed equipment such as electric switchboards.
- This instrument is an EN61326-1 (EMC standard) class A instrument (for use in commercial, industrial, or business environments). The influence rate (judgment condition A) in the immunity test environment is within  $\pm 10\%$  of the range.
- The general safety precautions described here must be observed during all phases of operation. If the SMARTDAC+ is used in a manner not described in this manual, the SMARTDAC+ safety features may be impaired. Yokogawa Electric Corporation assumes no liability for the customer's failure to comply with these requirements.
- The SMARTDAC+ is designed for indoor use.

### About This Manual

- Please pass this manual to the end user. We also ask you to store this manual in a safe place.
- This guide is intended for the following personnel: Engineers responsible for installation, wiring, and maintenance of the equipment.  
Personnel responsible for normal daily operation of the equipment.
- Read this manual thoroughly and have a clear understanding of the product before operation.
- This manual explains the functions of the product. It does not guarantee that the product will suit a particular purpose of the user.

### Precautions Related to the Protection, Safety, and Alteration of the Product

The following safety symbols are used on the product and in this manual.



"Handle with care." To avoid injury and damage to the instrument, the operator must refer to the explanation in the manual.



Protective ground terminal



Functional ground terminal  
(do not use this terminal as a protective ground terminal.)



Alternating current



Direct current



ON (power)



OFF (power)

- For the protection and safe use of the product and the system in which this product is incorporated, be sure to follow the instructions and precautions on safety that are stated in this manual whenever you handle the product.

Take special note that if you handle the product in a manner that violates these instructions, the protection functionality of the product may be damaged or impaired. In such cases, Yokogawa does not guarantee the quality, performance, function, and safety of product.

- When installing protection and/or safety circuits such as lightning protection devices and equipment for the product and control system or designing or installing separate protection and/or safety circuits for fool-proof design and fail-safe design of the processes and lines that use the product and the control system, the user should implement these using additional devices and equipment.
- If you are replacing parts or consumable items of the product, make sure to use parts specified by Yokogawa.
- This product is not designed or manufactured to be used in critical applications that directly affect or threaten human lives. Such applications include nuclear power equipment, devices using radioactivity, railway facilities, aviation equipment, air navigation facilities, aviation facilities, and medical equipment. If so used, it is the user's responsibility to include in the system additional equipment and devices that ensure personnel safety.
- Do not modify this product.



### Use the Correct Power Supply

Ensure that the source voltage matches the voltage of the power supply before turning ON the power. In the case of portable type and the GX60 (power inlet type), ensure that it is within the maximum rated voltage range of the provided power cord before connecting the power cord.

### Use the Correct Power Cord and Plug (Portable Type, GX60 (power inlet type))

To prevent electric shock or fire, be sure to use the power cord supplied by Yokogawa. The main power plug must be plugged into an outlet with a protective earth terminal. Do not disable this protection by using an extension cord without protective earth grounding.

The power cord is designed for use with this instrument. Do not use the power cord with other instruments.

### Connect the Protective Grounding Terminal

Make sure to connect the protective grounding to prevent electric shock before turning ON the power. The power cord that comes with the portable type and the GX60 (power inlet type) are three prong type power cord. Connect the power cord to a properly grounded three-prong outlet.

### Do Not Impair the Protective Grounding

Never cut off the internal or external protective grounding wire or dis-



---

connect the wiring of the protective grounding terminal. Doing so invalidates the protective functions of the instrument and poses a potential shock hazard.

- **Do Not Operate with Defective Protective Grounding**  
Do not operate the instrument if the protective grounding might be defective. Also, make sure to check them before operation.
- **Do Not Operate in an Explosive Atmosphere**  
Do not operate the instrument in the presence of flammable gas, vapors, or combustible dust. Operation in such an environment constitutes a safety hazard. Prolonged use in a highly dense corrosive gas (H<sub>2</sub>S, SO<sub>x</sub>, etc.) will cause a malfunction.
- **Do Not Remove Covers**  
The cover should be removed by Yokogawa's qualified personnel only. Opening the cover is dangerous, because some areas inside the instrument have high voltages.
- **Ground the Instrument before Making External Connections**  
Connect the protective grounding before connecting to the item under measurement or control unit.
- **Damage to the Protection**  
Operating the instrument in a manner not described in this manual may damage the instrument's protection.
- **Wiring**  
To prevent shock, attach the included terminal cover after wiring. Make sure to use appropriate wires and crimp-on lugs.  
If hazardous external voltage (30 V AC or 60 V DC or more) is applied to the I/O terminals, provide adequate protection to prevent users or service engineers from suddenly touching the terminals or tools or the like from coming in contact with the terminals.



**This instrument is a Class A product. Operation of this instrument in a residential area may cause radio interference, in which case the user is required to take appropriate measures to correct the interference.**

#### ■ Exemption from Responsibility

- Yokogawa makes no warranties regarding the product except those stated in the WARRANTY that is provided separately.
- Yokogawa assumes no liability to any party for any loss or damage, direct or indirect, caused by the user or any unpredictable defect of the product.

#### ■ Software Handling Precautions

- Yokogawa makes no warranties, either expressed or implied, with respect to the software's merchantability or suitability for any particular purpose, except as specified in the terms of the separately provided warranty.
- All reverse-engineering operations, such as reverse compilation or the reverse assembly of the product are strictly prohibited.
- No part of the product's software may be transferred, converted, or sublet for use by any third party, without prior written consent from Yokogawa.

About the Usage of Open Source Software  
关于开放源代码软件的使用

This products uses open source software.

For details on using open source software, see Regarding the Downloading and Installing

for the Software, Manuals and Labels (IM 04L61B01-11EN).

## Handling Precautions of the GX/GP

- Use care when cleaning this instrument, especially its plastic parts. Use a soft dry cloth. Do not use organic solvents, such as benzene or thinner, or other cleansers. They may cause discoloring and deformation.
- Keep electrically charged objects away from the signal terminals. Failure to do so may damage the GX/GP.
- Do not apply volatile chemicals to the display, panel keys, etc. Do not allow rubber and vinyl products to remain in contact with the GX/GP for long periods of time. Doing so may damage the GX/GP.
- When not in use, make sure to turn off the power switch.
- If there are any symptoms of trouble such as strange odors or smoke coming from the GX/GP, immediately turn off the power switch and the power supply source. Then, contact your nearest Yokogawa dealer.

## SD Memory Card Handling Precautions

- SD memory cards are delicate and should be handled with caution.
- Yokogawa provides no warranty for damage to, or loss of data recorded on the SD memory card, regardless of the cause of such damage or loss. Please always make backup copies of your data.
- Do not store or use the SD memory card in places with static electricity, near electrically charged objects, or where electrical noise is present. Doing so can result in electric shock or damage.
- Do not disassemble or modify the SD memory card. Doing so can result in damage.
- Do not physically shock, bend, or pinch the SD memory card. Doing so can lead to malfunction.
- During reading/writing of data, do not turn OFF the power, apply vibration or shock, or pull out the card. Data can become corrupt or permanently lost.
- Only use Yokogawa SD memory cards. Operation cannot be guaranteed with other brands of card.
- When inserting the SD memory card into the instrument, make sure you orient the card correctly (face up or down) and that you insert it securely. If not inserted correctly, the card will not be recognized by the instrument.
- Never touch the SD memory card with wet hands. Doing so can lead to electric shock or malfunction.
- Never use the SD memory card if it is dusty or dirty. Doing so can lead to electric shock or malfunction.
- The SD memory card comes formatted.  
SD cards must be formatted according to the standard established by the SD Association (<https://www.sdcard.org/home>). If you want format the SD memory card, use the instrument's Format function. If using a PC to perform the formatting, use the SD card formatter software available from the above SD Association.
- You can use SD/SDHC cards (up to 32 GB) on the GX/GP.

## SD Memory Card Specifications and Characteristics

Electrical specifications	Operating voltage: 2.7 V to 3.6 V (memory operation)
Operating temperature / humidity conditions	–25 to 85°C / 20 to 85% RH, no condensation
Storage temperature / humidity conditions	–40 to 85°C / 5 to 95% RH, no condensation

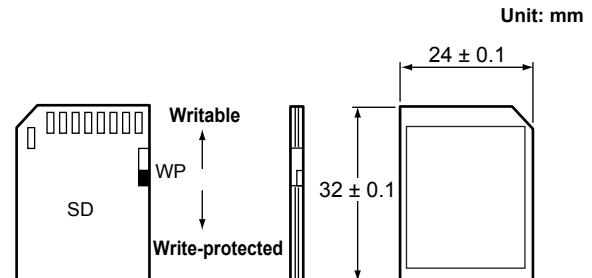

## Checking the Package Contents

After receiving the product and opening the package, check the items described below. If the wrong items have been delivered, if items are missing, or if there is a problem with the appearance of the items, contact your nearest Yokogawa dealer.

Check that the product that you received is what you ordered by referring to the model name and suffix code given on the name plate on the GX/GP.

### NO. (Instrument Number)

When contacting the dealer from which you purchased the instrument, please give them the instrument number.

## MODEL and SUFFIX Codes

### GX10/GX20<sup>13</sup>

Model	Suffix Code	Optional Code	Description
GX10			Paperless recorder (Panel mount type, Small display)
GX20			Paperless recorder (Panel mount type, Large display)
Type	-1		Standard (max. no. of measurement ch : 100)
	-2		Large Memory (max. no. of measurement ch : 500) <sup>4,12</sup>
Language	E		English, degF, DST (summer/winter time) <sup>10</sup>
Options	/AH		Aerospace heat treatment
	/AS		Advanced security function
	/BC		Black cover
	/BT		Multi-batch function
	/C2		RS-232 <sup>1</sup>
	/C3		RS-422/485 <sup>1</sup>
	/CG		Custom display function
	/D5		VGA output <sup>2</sup>
	/E1		EtherNet/IP communication (PLC communication protocol) <sup>19</sup>
	/E2		WT communication <sup>14</sup>
	/E3		OPC-UA server
	/E4		SLMP communication (Mitsubishi PLC) <sup>20</sup>
	/FL		Fail output, 1 point
	/LG		LOG scale
	/MT		Mathematical function (with report function) <sup>15, 18</sup>
	/MC		Communication channel function <sup>21</sup>
	/P1		24 VDC/AC power supply <sup>4</sup>
	/PG		Program control function <sup>22</sup>
	/UH		USB Interface (host 2 ports)
	/UC[ ]0		Analog (universal) input module preinstalled (clamp terminal) <sup>3</sup>
/US[ ]0		Analog (universal) input module preinstalled (M3 screw terminal) <sup>3</sup>	
/CR[ ][ ]		Digital output module, digital input module preinstalled <sup>5</sup>	

### GP10/GP20<sup>13</sup>

Model	Suffix Code	Optional Code	Description
GP10			Paperless recorder (Portable type, Small display)
GP20			Paperless recorder (Portable type, Large display)
Type	-1		Standard (max. no. of measurement ch : 100)
	-2		Large Memory (max. no. of measurement ch : 500) <sup>12</sup>
Language	E		English, degF, DST (summer/winter time) <sup>10</sup>
Power supply	1		100 VAC, 240 VAC <sup>16</sup>
	2		12V DC <sup>17</sup>
Power cord	D		Power cord UL/CSA standard
	F		Power cord VDE standard
	R		Power cord AS standard
	Q		Power cord BS standard
	H		Power cord GB standard
	N		Power cord NBR standard
	W		Screw terminal, power cord not included
Options	/AH		Aerospace heat treatment
	/AS		Advanced security function
	/BT		Multi-batch function
	/C2		RS-232 <sup>1</sup>
	/C3		RS-422/485 <sup>1</sup>
	/CG		Custom display function
	/D5		VGA output <sup>2</sup>
	/E1		EtherNet/IP communication (PLC communication protocol) <sup>19</sup>
	/E2		WT communication <sup>14</sup>
	/E3		OPC-UA server
	/E4		SLMP communication (Mitsubishi PLC) <sup>20</sup>
	/FL		Fail output, 1 point
	/LG		LOG scale
	/MT		Mathematical function (with report function) <sup>15, 18</sup>
	/MC		Communication channel function <sup>21</sup>
	/PG		Program control function <sup>22</sup>
	/UH		USB interface (host 2 ports)
	/UC[ ]0		Analog (universal) input module preinstalled (clamp terminal) <sup>3</sup>
	/US[ ]0		Analog (universal) input module preinstalled (M3 screw terminal) <sup>3</sup>
	/CR[ ][ ]		Digital output module, digital input module preinstalled <sup>5</sup>

### Models in Which I/O Modules Are Preinstalled

Model	Suffix Code	Optional Code	Description
GX10	-□E/[ ][ ]		Paperless recorder (panel mount type)
GX20			
GP10	-□E1/[ ][ ]		Paperless recorder (portable type)
GP20			
Options (analog Input) <sup>3, 11</sup>	/UC10		With analog input module, 10ch (Clamp terminal)
	/UC20		With analog input module, 20ch (Clamp terminal) <sup>7</sup>
	/UC30		With analog input module, 30ch (Clamp terminal) <sup>8</sup>
	/UC40		With analog input module, 40ch (Clamp terminal) <sup>5</sup>
	/UC50		With analog input module, 50ch (Clamp terminal) <sup>5</sup>
	/US10		With 10ch analog input module (M3 screw terminal)
	/US20		With 20ch analog input module (M3 screw terminal) <sup>7</sup>
	/US30		With 30ch analog input module (M3 screw terminal) <sup>8</sup>
	/US40		With 40ch analog input module (M3 screw terminal) <sup>5</sup>
	/US50		With 50ch analog input module (M3 screw terminal) <sup>5</sup>
Options (digital I/O) <sup>4</sup>	/CR01		With digital I/O module (output: 0, input: 16) <sup>8, 9, 15</sup>
	/CR10		With digital I/O module (output: 6, input: 0) <sup>8</sup>
	/CR11		With digital I/O module (output: 6, input: 16) <sup>7, 8, 9, 15</sup>
	/CR20		With digital I/O module (output: 12, input: 0) <sup>6</sup>
	/CR21		With digital I/O module (output: 12, input: 16) <sup>6, 9, 15</sup>
	/CR40		With digital I/O module (output: 24, input: 0) <sup>6</sup>
/CR41		With digital I/O module (output: 24, input: 16) <sup>6, 9, 15</sup>	

- 1 /C2 and /C3 cannot be specified together.
- 2 /D5 can be specified only for the GX20/GP20.
- 3 Only one option can be specified.
- 4 Only one option can be specified.
- 5 /UC40, /UC50, /US40, and /US50 cannot be specified for the GX10/GP10.
- 6 /CR20, /CR21, /CR40, and /CR41 cannot be specified for the GX10/GP10.
- 7 If /UC20 or /US20 is specified for the GX10/GP10, /CR11 cannot be specified.
- 8 If /UC30 or /US30 is specified for the GX10/GP10, /CR01, /CR10, and /CR11 cannot be specified.
- 9 A digital input module has M3 screw terminals.
- 10 The Display language is selectable from English, German, French, Russian, Korean, Chinese, Japanese.  
To confirm the current available languages, please visit the following website.  
URL: [www.yokogawa.com/ns/language/](http://www.yokogawa.com/ns/language/)
- 11 Solid state relay type (Type Suffix Code: -U2).
- 12 Can be specified only for the GX20/GP20.
- 13 To connect an I/O base unit, you will need one I/O expansion module for the GX/GP.
- 14 /MC option must be separately specified when the WT communication is selected.
- 15 Optional code /MT (MATH) required if using the GX90XD's or GX90WD's pulse input.
- 16 Selectable only when the power cord suffix code is D or F or R or Q or H or N.
- 17 Selectable only for the GP10 when the power cord suffix code is W.
- 18 The /MT option (computation) is required to perform pulse integration on GX90XP pulse input modules.
- 19 If you want to write from a PLC to the GX/GP via EtherNet/IP communication, a separate communication channel (/MC) is required.
- 20 If you want the GX/GP to load data from SLMP servers via SLMP communication, a separate communication channel (/MC) is required.
- 21 If you want to load data from other devices into the GX/GP using Modbus client, a communication channel (/MC) is required.
- 22 This is applicable only when a GX90UT PID Control Module is installed.

## I/O Modules

### GX90XA

Model	Suffix Code			Description
GX90XA				Analog Input Module
Channels	-04			4 channels (Type -H0 only)
	-06			6 channels (Type -R1 only)
	-10			10 channels (Type -C1, -L1, -U2, -T1, -V1)
Type	-C1			Current, Scanner type (isolated between channels)
	-L1			DCV/TC/DI (400 VAC, 1 min), Scanner type (isolated between channels)
	-U2			Universal, Solid state relay scanner type (3-wire RTD b-terminal common)
	-T1			DCV/TC/DI, Electromagnetic relay scanner type (isolated between channels)
	-H0			High-speed universal, individual A/D type (isolated between channels)
	-R1			4-wire RTD/resistance, scanner type (isolated between channels)
	-V1			DCV/TC/DI, high withstand voltage scanner type (isolated between channels)
-		N		Always N
Terminal type			-3	Screw terminal (M3)
			-C	Clamp terminal
Area			N	General

### I/O Base Unit (Expandable I/O) <sup>1</sup>

Model	Suffix Code			Description
GX60				I/O base unit
Type	-EX			I/O Expansion
Area			N	General
Power supply			1	100 VAC, 240 VAC
Power cord		D		Power cord UL/CSA standard
		F		Power cord VDE standard
		R		Power cord AS standard
		Q		Power cord BS standard
		H		Power cord GB standard
		N		Power cord NBR standard
		W		Screw terminal, power cord not included <sup>2</sup>

- 1 Include GX90EX (Expansion module), Stopper (antiskid rubber)
- 2 Intended use for panel or rack mounting only.

### I/O Expansion Module (Expansion Module)

Model	Suffix Code			Description
GX90EX				I/O Expansion Module
Port	-02			2 ports
Type		-TP1		Twisted pair cable
-			N	Always N
Area			-N	General

### GX90XD

Model	Suffix Code			Description
GX90XD				Digital Input Module <sup>1</sup>
Channels	-16			16 channels
Type		-11		Open collector/Non-voltage, contact (shared common), Rated 5 VDC
-			N	Always N
Terminal type			-3	Screw terminal (M3)
			-C	Clamp terminal
Area			N	General

- 1 Optional code /MT (MATH) required if using the pulse input.

### GX90YD

Model	Suffix Code			Description
GX90YD				Digital Output Module
Channels	-06			6 channels
Type		-11		Relay, SPDT(NO-C-NC)
-			N	Always N
Terminal type			-3	Screw terminal (M3)
Area			N	General

### GX90WD

Model	Suffix Code			Description
GX90WD				Digital Input/Output Module <sup>1</sup>
Channels	-0806			Input 8 channels, Output 6 channels
Type		-01		Open collector/non-voltage contact (shared common), rated 5 VDC; Relay, SPDT (NO-C-NC)
-			N	Always N
Terminal type			-3	Screw terminal (M3)
Area			N	General

- 1 Optional code /MT (MATH) required if using the pulse input.

## GX90XP

Model	Suffix Code	Description
GX90XP		Pulse Input Module <sup>1</sup>
Channels	-10	10 channels
Type	-11	DC voltage/Open collector/Non-voltage, contact (shared common), Rated 5 VDC
-	N	Always N
Terminal type	-3	Screw terminal (M3)
	-C	Clamp terminal
Area	N	General

<sup>1</sup> The /MT option (computation) is required to perform pulse integration.

## GX90YA

Model	Suffix Code	Description
GX90YA		Analog Output Module
Channels	-04	4 channels
Type	-C1	Current output (isolated between channels)
-	N	Always N
Terminal type	-3	Screw terminal (M3)
	-C	Clamp terminal
Area	N	General

## GX90UT

Model	Suffix Code	Description
GX90UT		PID Control Module
Number of loops	-02	2 loops
Function	-11	DI 8 points, DO 8 points
-	N	Always N
Terminal type	-3	Screw terminal (M3)
Area	N	General

### ■ Customized Product

For customized product, the product is identified by the option code of /S# (where '#' is a number). Contact your supplier in case your instrument has option /S#, and you are not in the possession of IM [Model code]-S# (where [Model code] means, for example, GX90XA).

## Standard Accessories

The instrument is shipped with the following accessories. Make sure that all accessories are present and undamaged.

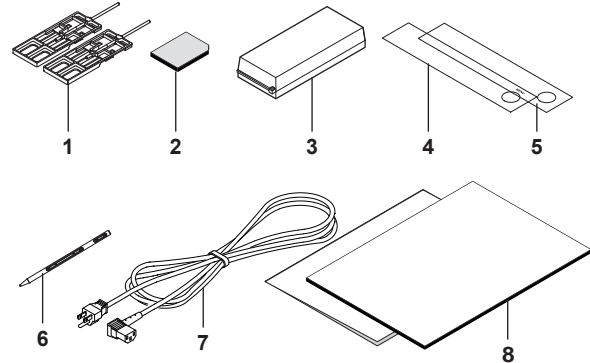

No.	Name	Part Number/Model	Qty.	Notes
1	Mounting bracket	B8740DY	2	GX10/GX20 only
2	SD memory card	773001	1	1GB
3	Dummy cover	B8740CZ		For empty slots
4	Tag plate	B8740FE	1	GX20
		B8740ME	1	GP20
		B8741FE	1	GX10
		B8741ME		GP10
5	Sheet	B8740FF	1	GX20
		B8740MF	1	GP20
		B8741FF	1	GX10
		B8741MF	1	GP10
6	Stylus	B8740BZ	1	
7	Power cord	A1006WD	1	D: Power cord UL, CSA st'd <sup>1</sup>
		A1009WD	1	F: Power cord VDE st'd <sup>1</sup>
		A1024WD	1	R: Power cord AS st'd <sup>1</sup>
		A1054WD	1	Q: Power cord BS st'd <sup>1</sup>
		A1064WD	1	H: Power cord GB st'd <sup>1</sup>
		A1088WD	1	N: Power cord NBR st'd <sup>1</sup>
8	Manual	IM 04L51B01-02EN	1	First Step Guide (This manual)
		IM 04L61B01-11EN	1	Regarding the Downloading and Installing for the Software, Manuals and Labels/About the Usage of Open Source Software

<sup>1</sup> Except GP10 power supply suffix code: 2

## Optional Accessories (Sold separately)

Name	Part Number/Model	Minimum Qty	Notes
Mounting bracket	B8740DY	2	GX10/GX20 only
SD memory card	773001	1	1GB
Stylus	B8740BZ	1	
Shunt resistor (for M3 screw terminal)	415940	1	250 Ω ± 0.1%
	415941	1	100 Ω ± 0.1%
	415942	1	10 Ω ± 0.1%
Shunt resistor (for clamp terminal)	438920	1	250 Ω ± 0.1%
	438921	1	100 Ω ± 0.1%
	438922	1	10 Ω ± 0.1%
Dummy cover	B8740CZ	1	For module slot

## GX/GP Style Number, Release Number, and Firmware Version Number

Style number: The GX/GP hardware ID number. This number is written on the name plate (H column).

Release number: The GX/GP firmware ID number. This number is written on the name plate (S column). This number matches with the integer part of the firmware version number.

Example: If the firmware version number is 1.01, the release number is 1.

Firmware version number:

This number appears on the system information screen of the GX/GP. To view the number, see section 2.3, "Displaying Various Types of Information" in the User's Manual, IM 04L51B01-01EN.

## Conventions Used in This Manual

- This manual covers information regarding GX/GPs whose display language is English.
- For details on the language setting, see the Paperless Recorder User's Manual, IM04L51B01-01EN.

Unit

K: Denotes 1024. Example: 768K (file size)

k: Denotes 1000.

The notes and cautions in this manual are indicated using the following symbols.



Improper handling or use can lead to injury to the user or damage to the instrument. This symbol appears on the instrument to indicate that the user must refer to the user's manual for special instructions. The same symbol appears in the corresponding place in the user's manual to identify those instructions. In the manual, the symbol is used in conjunction with the word "WARNING" or "CAUTION."

### WARNING

Calls attention to actions or conditions that could cause serious or fatal injury to the user, and precautions that can be taken to prevent such occurrences.

### CAUTION

Calls attentions to actions or conditions that could cause light injury to the user or damage to the instrument or user's data, and precautions that can be taken to prevent such occurrences.

### Note

Calls attention to information that is important for proper operation of the instrument.

## Module Notation

When necessary, the following notations are used to distinguish the GX90XA analog input modules by type.

Type Suffix Code	Notation
-U2	Universal
-C1	Current (mA)
-L1	Low withstand voltage relay
-T1	Electromagnetic relay
-H0	High-speed universal or High speed AI
-R1	4-wire RTD/resistance
-V1	High withstand voltage

## Protection of Environment

### Control of Pollution Caused by the Product

This is an explanation for the product based on “Control of pollution caused by Electronic Information Products” in the People’s Republic of China.

产品中有毒有害物质或元素的名称及含量

部件名称	有毒有害物质或元素					
	铅 (Pb)	汞 (Hg)	镉 (Cd)	六价铬 (Cr6+)	多溴联苯 (PBB)	多溴二苯醚 (PBDB)
印制电路板	N/A	N/A	N/A	✓	✓	✓
内部接线材料	N/A	N/A	N/A	✓	✓	✓
外壳/ 机箱	塑料	N/A	N/A	✓	✓	✓
	金属	N/A	N/A	✓	✓	✓
I/O 模块外壳	N/A	N/A	N/A	✓	✓	✓
电源	N/A	N/A	N/A	✓	✓	✓
正面边框	N/A	N/A	N/A	✓	✓	✓
标准附件/ 可选附件	显示器 (LCD)	N/A	N/A	✓	✓	✓
	安装支架	N/A	N/A	✓	✓	✓
	电源线 (GP10/GP20/GX60 (的插口型))	N/A	N/A	✓	✓	✓
	SD 存储卡	N/A	N/A	✓	✓	✓
	分流电阻	N/A	N/A	✓	✓	✓

✓: 表示该部件的所有均质材料中的有毒有害物质或元素的含量均低于GB/T 26572 标准所规定的限量要求。

N/A: 表示该部件中至少有一种均质材料中的有毒有害物质或元素的含量超过GB/T 26572 标准所规定的限量要求。

本产品的部分部件包含RoHS指令中的限用物质，但是其使用方法不受该指令限制。

Some parts of this product include the restricted substances of RoHS Directive, but their applications are under the exemption of the directive.



该标志为环境保护使用期限，根据SJ/T11364，适用于在中国(台湾、香港、澳门除外)销售的电子电气产品。只要遵守该产品的安全及使用注意事项，从产品生产之日起至该标志所示年限内，不会因为产品中的有害物质外泄或突变而导致环境污染或对人身财产产生重大影响。

注释) 该标志所示年限为“环境保护使用期限”，并非产品的保质期。另外，关于更换部件的推荐更换周期，请参阅使用说明书。

### Waste Electrical and Electronic Equipment (WEEE), Directive



This is an explanation of how to dispose of this product based on Waste Electrical and Electronic Equipment (WEEE), Directive. This directive is only valid in the EU.

- Marking

This product complies with the WEEE Directive marking requirement. This marking indicates that you must not discard this electrical/electronic product in domestic household waste.

- Product Category

With reference to the equipment types in the WEEE directive, this product is classified as a “Small equipment” product.

Do not dispose in domestic household waste.

When disposing products in the EU, contact your local Yokogawa Europe B.V. office.

### How to Dispose the Batteries



This is an explanation about the EU Battery Directive This directive is only valid in the EU.

Batteries are included in this product. Batteries incorporated into this product cannot be removed by yourself. Dispose them together with this product. When you dispose this product in the EU, contact your local Yokogawa Europe B.V.office. Do not dispose them as domestic household waste.

Battery type: Lithium battery

Notice: The symbol (see above) means they shall be sorted out and collected as ordained in ANNEX II in DIRECTIVE 2006/66/EC.

# Functional Overview

## Overview

The GX/GP is a paperless recorder that can display measured data in real time on its touch screen and save the data in an SD memory card.

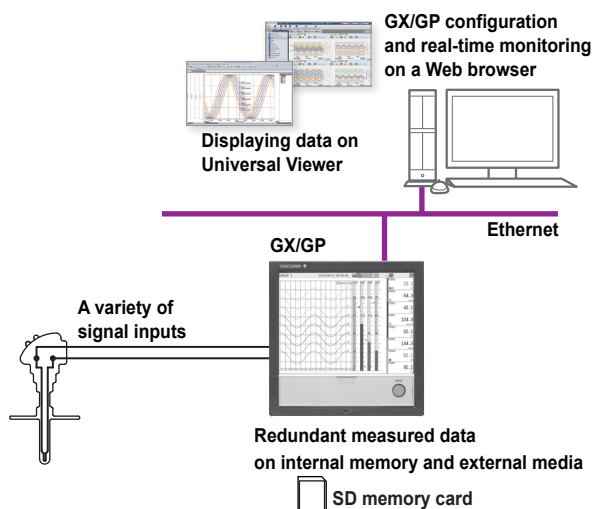

## A Variety of Source Signals

The GX/GP can connect to DC voltage, TC, RTD, ON/OFF, DC current (mA) and pulse inputs and measure temperature, flow rate, and other parameters. The GX/GP acquires data by sampling input signals at the set scan interval. The shortest scan interval is 1 ms (High-speed AI module). Up to four alarm conditions can be specified on each measurement channel.

## Expandable Module Construction

The I/O section is modular, so you can configure your system according to the input types and number of measurement points.

Modules

Model	Name	Channels
GX90XA	Analog input module	4/6/10
GX90XD	Digital input module	16
GX90YD	Digital output module	6
GX90WD	Digital Input/Output Module	Input : 8 , Output : 6
GX90XP	Pulse Input Module	10
GX90YA	Analog output module	4
GX90UT	PID Control Module	26

- Up to 10 modules can be installed in the GX20/GP20.
- Up to 3 modules can be installed in the GX10/GP10.
- Different modules can coexist.

\* Up to nine modules for the GX20/GP20 and two modules for the GX10/GP10 when an GX60 is connected.

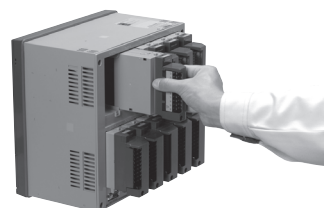

Detachable module terminal block

Maintenance is easy!

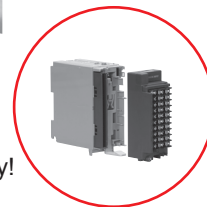

## GX60 Connection and Multichannel Measurement

An GX60 I/O can be connected to the GX20/GP20 to measure up to 450 channels. On the standard type, you can connect the GX60 to allocate input sections at different locations.

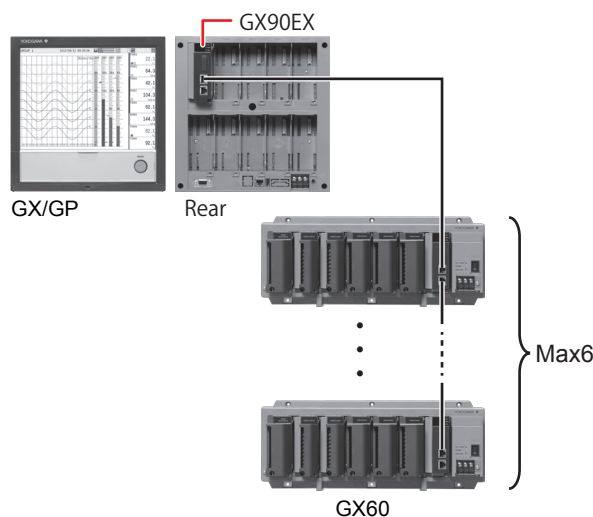

GX/GP configuration

Item	GX/GP	
	Standard Type	Large Memory Type
Maximum number of connectable GX60	6	6
Maximum number of I/O modules (main unit + GX60)	10 <sup>1</sup>	45 <sup>2</sup>
Maximum number of I/O channels	100	500

- 1 2 on the rear of the GX10/GP10, 9 on the rear of the GX20/GP20.
- 2 9 on the rear of the GX20/GP20.



## High-speed Measurement, Dual Interval Measurement (Measurement mode)

The GX/GP has measurement modes to allow high-speed measurement and simultaneous measurement of slow and fast signals.

In high-speed measurement, a high-speed AI module can be installed to achieve measurement at the shortest interval of 1 ms.

In dual interval measurement, measurement can be performed by two measurement groups with different scan intervals.

Various measurements can be performed by changing the measurement mode according to the measurement target and measurement conditions.

## Loop Control and Program Control Function (/PG Option)

By installing a PID Control Module (GX90UT), you can perform PID control of up to 20 loops (up to 6 loops for the GX10/GP10). In addition to control loop monitoring and the control group screen for convenient operation, adjustment using the tuning screen is available. Adding the /PG option to the GX/GP main unit allows 99 patterns and 99 segments of program patterns to be stored in the main unit. Further, 32 time events can be set.

## Data Storage

There are two ways to store data. One way is to record measured data at all times (display data and event data). The other way is to record only when events, such as alarms, occur (event data). Measured data is saved to the internal memory at the specified interval. Data in the internal memory can be saved to the SD memory card automatically or manually. Measured data can be transferred automatically to an FTP server over an Ethernet connection.

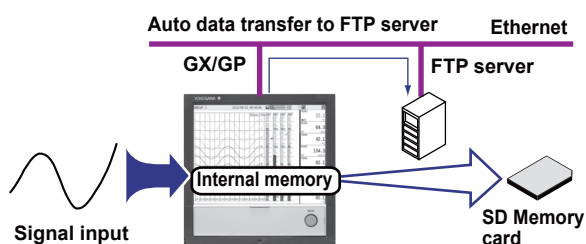

## A Variety of Display Functions

Measured data can be displayed in groups as trend waveforms, values, and bar graphs. There is also an overview display that you can monitor all channels on a single screen.

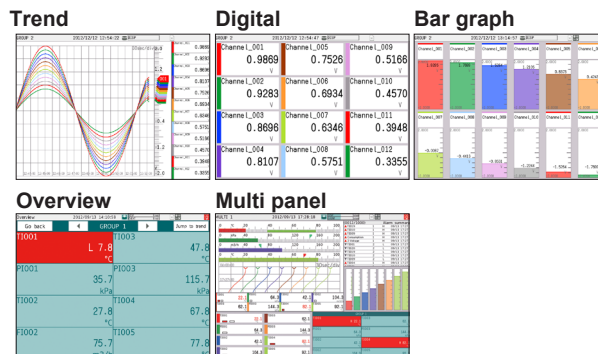

## Custom Display (Option, /CG)

You can control and monitor on a custom display consisting of digital, trend, bar graph, and other components and images can that are laid out freely. Custom displays are created using DAQStudio (DXA170), a software application sold separately. Displays that you create are loaded into the GX/GP from DAQStudio or from an external storage medium.

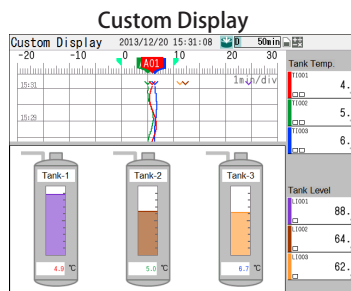

## Touch Screen

The GX/GP touch screen enables intuitive operation. You can tap the icons of setup and operation items as well as scroll and zoom in on and out of waveforms by directly touching the screen. In addition, when you are working on-site, you can operate the GX/GP with your gloves on.



## Touch Operations

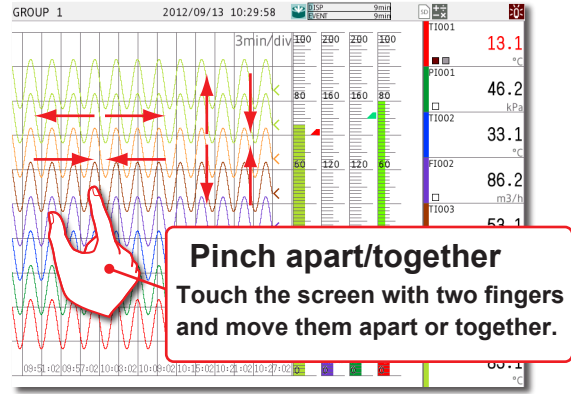
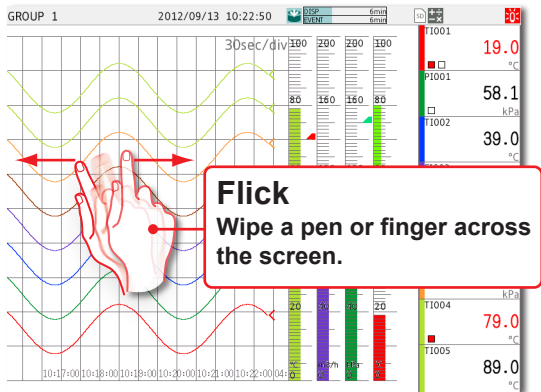
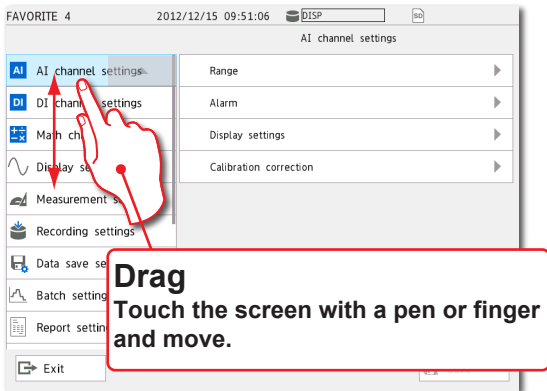
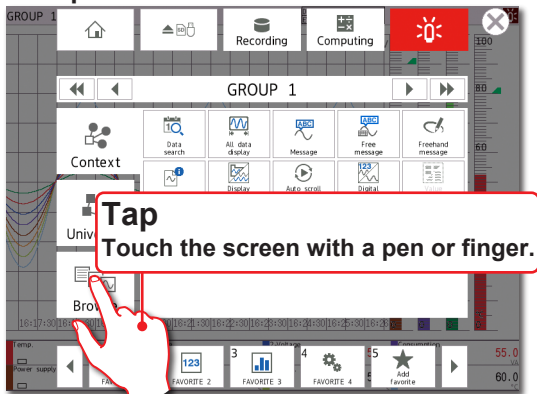

## Freehand Messages

You can use the touch pen or your finger to write text and draw marks freely in the waveform area. The messages that you write can easily be displayed from information displays such as the message summary and memory summary.

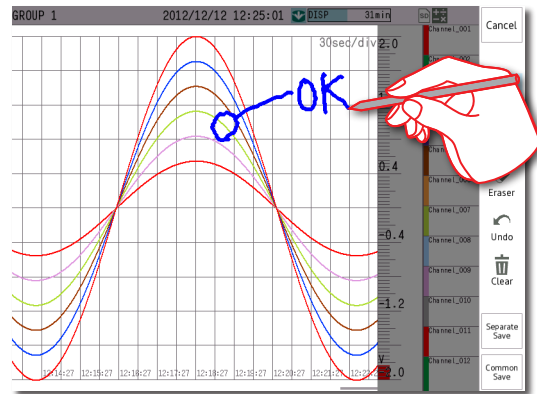

## Versatile Network Functions and Software

The Ethernet interface enables you to monitor the GX/GP from a Web browser. E-mails can be sent through this interface when alarms and other events occur. In addition, you can use the Modbus protocol to read data from other devices on the network and display it. As for the software, Universal Viewer can be used to view measured data and convert the data into other data formats.

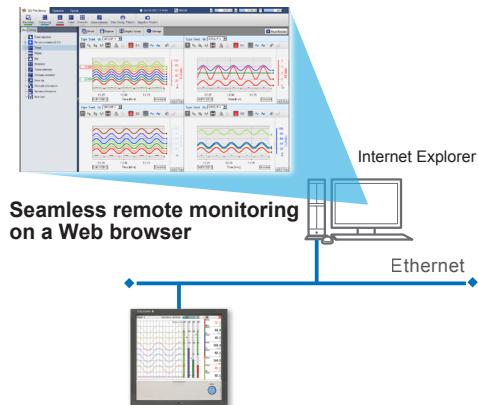

## Other Functions

Math function (/MT option)	Expressions can be assigned to math channels to perform various computations. Logic math can output calculated results as 0 or 1 to DOs or internal switches. Computation is performed regardless of the math start/stop condition.
FAIL output (/FL option)	This function transmits alarms when the GX/GP fails.
Security function	You can allow only registered users to use the GX/GP. In addition, certain operations can be prohibited.
Remote control	This function executes specified operations by combining input modules and the event action function.
Advanced security function (/AS option)	A security function that complies with US FDA 21CFR Part11. Electronic signatures can be added to measured data.
EtherNet/IP communication (/E1 option)	This function is equipped with a server function that enables communication with EtherNet/IP devices.
WT communication (/E2 option)	This function acquires measured and calculated data from a power meter and displays and records it along with the measured values of the GX/GP.
LOG scale (/LG option)	This function measures logarithmic voltage that has been converted from a physical value, scales the voltage, and displays the resultant data.
Aerospace heat treatment (/AH option)	Supports aerospace heat treatment measurements and NADCAP AMS2750E compliant recording and reporting. Manage user-defined schedules for periodical execution.
Multi batch (/BT option)	Start and stop recording separately for each batch and create data files for each batch.
OPC-UA server (/E3 option)	Equipped with an OPC-UA server function. GX/GP measurement data can be retrieved directly from a host system, such as SCADA and MES.
SLMP communication (/E4 option)	Equipped with a client function for the MC protocol. Connection to Mitsubishi Electric PLCs can be established easily.

# System Configuration

You can configure a GX/GP system as shown below.

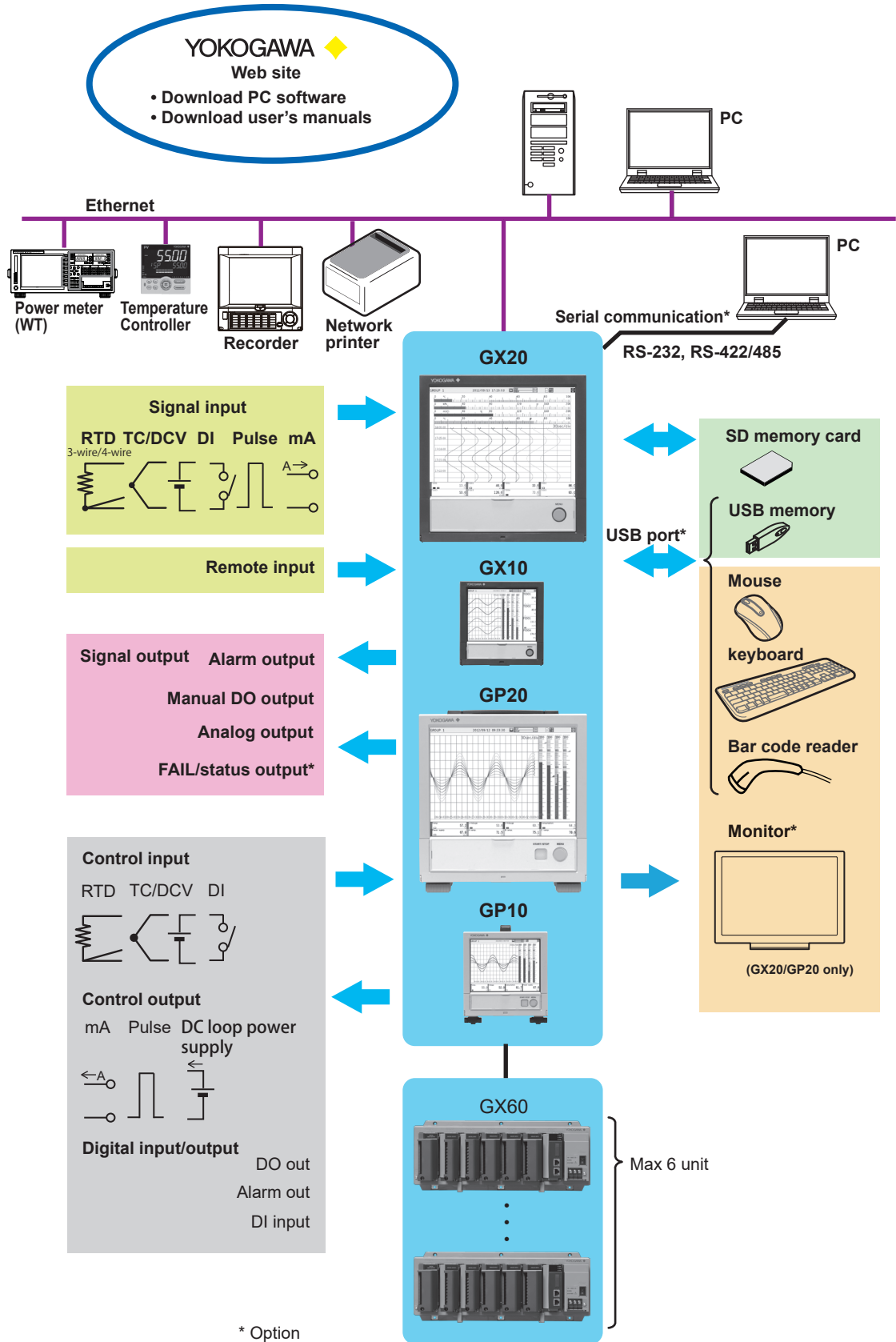

# Component Names

## GX20/GX10

### GX20 front panel

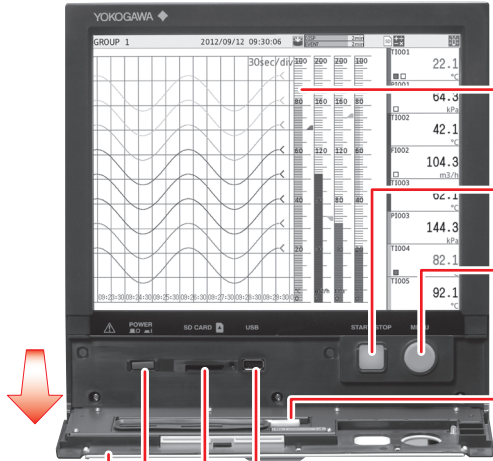

- LCD**  
Shows the trend display and other displays and the setup screen
- START/STOP key**  
Starts and stops recording
- MENU key**  
Press this once to show a menu for accessing various screens.

### GX10 front panel



### GX10 rear panel

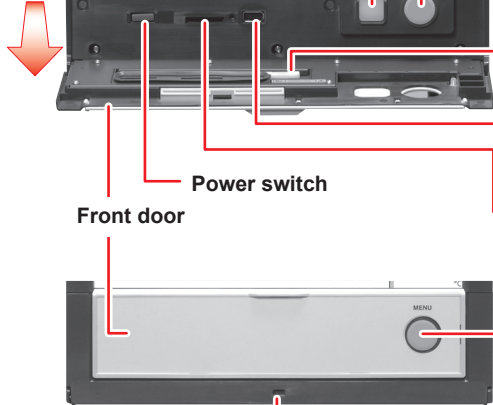

- Power switch**
- Front door**

- Stylus pen (touch pen)**
- USB port (/UH option)**  
USB2.0 compliant. Connect a USB memory device, mouse, keyboard, etc.
- SD memory card slot**  
SD memory card (up to 32 GB)  
Format: FAT32 or FAT16  
A 1 GB card is included.



- MENU key**  
Alarms are indicated with a red LED.
- Front door lock mechanism**  
A front door is locked/unlocked by a slide at the bottom.

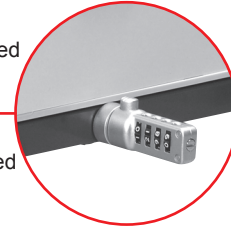

Use an off-the-shelf door lock key.

### GX20 rear panel

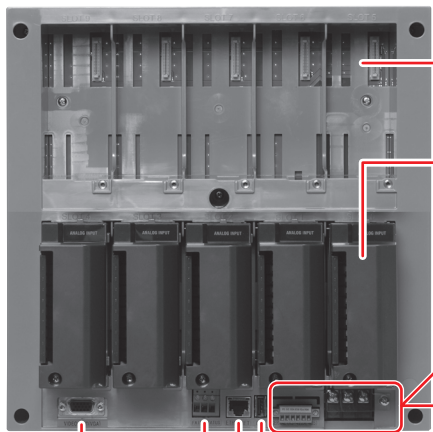

- I/O module slot**  
GX10, GP10: 3 slots (0 to 2)  
GX20, GP20: 10 slots (0 to 9)
- I/O module**  
Connect I/O signals.

- Power inlet (GP10/GP20)**
- Serial port (/C2 option)**  
RS-232 terminal
- Power supply terminal and protective ground terminal (GX10/GX20)**
- Serial port (/C3 option)**  
RS-422/485 terminal

- USB port (/UH option)**  
USB 2.0 compliant. Connect a USB memory device, mouse, keyboard, etc.
- Ethernet port**  
10BASE-T/100BASE-TX port
- FAIL output terminal (/FL option)**
- VGA output connector (/D5 option)**  
Connects to an external monitor

**GP20/GP10**

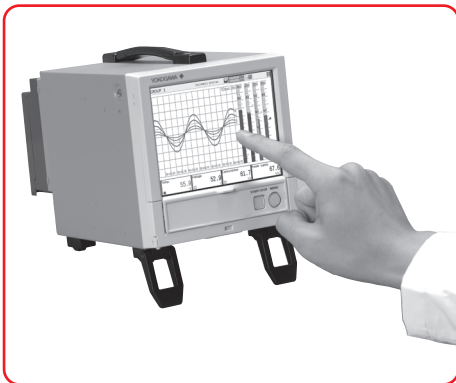
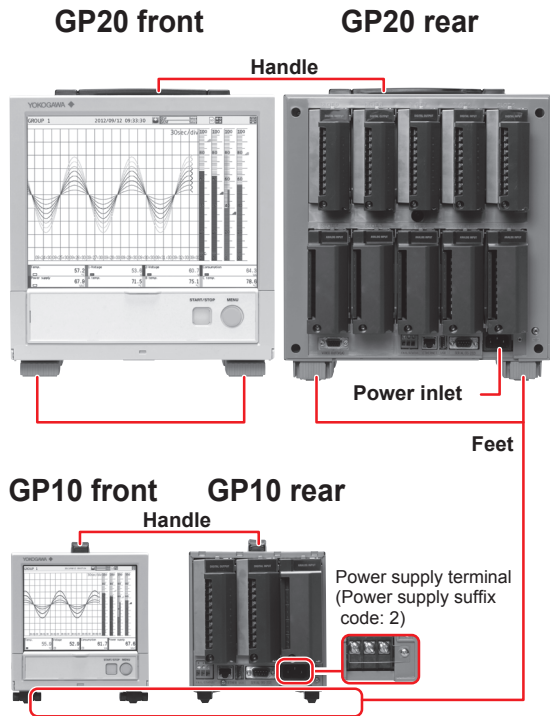

**GX60/GX90EX**

**GX60 I/O Base Unit (Expandable I/O)**

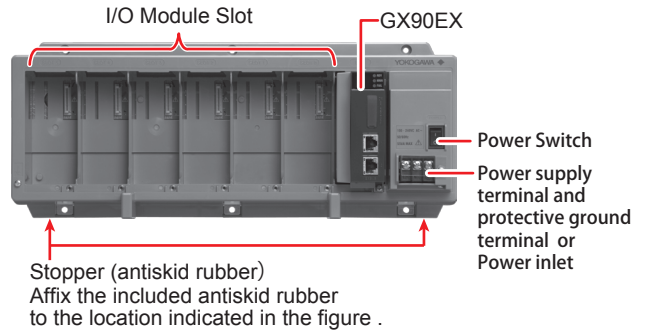

**GX90EX Expansion Module**

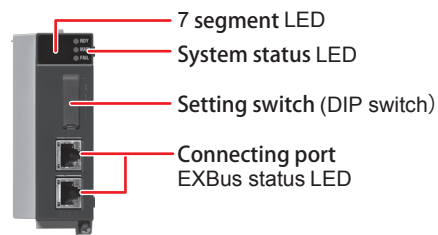

**GX90XA/GX90XD/GX90YD/GX90WD/  
GX90XP/GX90YA/GX90UT**

**GX90XA Analog Input Module**

M3 screw terminal



Clamp terminal



Terminal block release levers

**GX90XD Digital Input Module**

M3 screw terminal

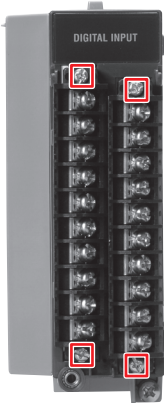

Clamp terminal



Terminal block attachment screws

**GX90YD Digital Output Module**

M3 screw terminal



Terminal block attachment screws

**GX90WD Digital Input/Output Module**

M3 screw terminal



Terminal block release levers

**GX90XP Pulse Input Module**

M3 screw terminal



Clamp terminal



Terminal block attachment screws

**GX90YA Analog Output Module**

M3 screw terminal



Clamp terminal



Terminal block attachment screws

**Component Names**

**GX90UT PID Control Module**

M3 screw terminal



Terminal block release levers



**WARNING** To prevent electric shock when you attach or remove terminal covers or terminal blocks, be sure that the power supply is turned off.

**Removing and Attaching a Terminal Cover**

**Removing the Terminal Cover**

Loosen the screw at the bottom section of the terminal cover, and remove the cover.

**Attaching the Terminal Cover**

1. Insert the two hooks at the top section on the inside of the terminal cover into A, and push the bottom section of the terminal cover.
2. Fasten the screw at the bottom section of the terminal cover to fix the cover in place.

Recommended tightening torque: 0.6 N•m

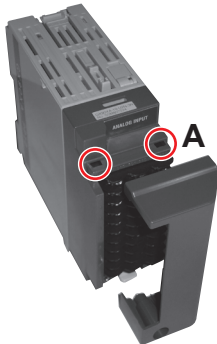

The shape of the cover varies depending on the module, but the procedure is the same.

**Removing and Attaching a Terminal Block**

**Removing the GX90XA Terminal Block**

Push down on the lever at the bottom section of the module, and pull the terminal block out.

**Attaching the GX90XA Terminal Block**

Insert the terminal block into the module, and push the lever firmly against the module (at the position indicated by the arrow in the figure).

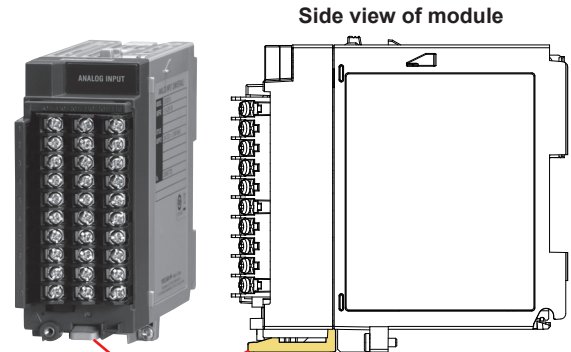

Side view of module

Terminal block release lever

For modules other than the GX90XA, you can use the attachment screw to remove and attach them.

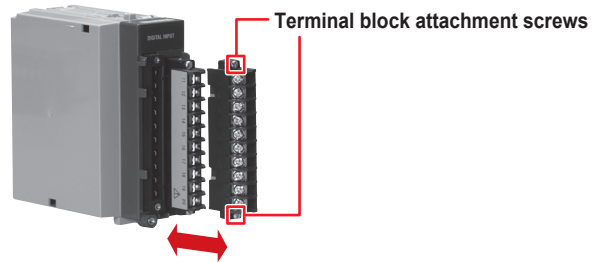

Terminal block attachment screws

Recommended torque for tightening the terminal block attachment screws: 0.1 N•m



Blank

When you are using the GX/GP for the first time, following the procedure below to quickly start measuring and recording.

# Operating Procedure

Product user's manuals can be downloaded or viewed at the following URL;  
**URL: [www.smartdacplus.com/manual/en/](http://www.smartdacplus.com/manual/en/)**

▶ **Manuals for reference**

▶ First Step Guide (This manual) (IM 04L51B01-02EN) "Installation and Wiring" Connect an GX60

▶ First Step Guide (This manual) (IM 04L51B01-02EN) "Installation and Wiring" Installing and Removing I/O Modules

▶ First Step Guide (This manual) (IM 04L51B01-02EN) "Installation and Wiring" Wiring

▶ First Step Guide (This manual) (IM 04L51B01-02EN) "Basic Operations" Turning the Power On and Off

▶ First Step Guide (This manual) (IM 04L51B01-02EN) "Setting the Measurement Mode" Setting the Measurement Mode

▶ First Step Guide (This manual) (IM 04L51B01-02EN) "Reconfiguring the GX/GP"

▶ First Step Guide (This manual) (IM 04L51B01-02EN) "Basic Operations" Setting the Date and Time

▶ First Step Guide (This manual) (IM 04L51B01-02EN) "Basic Operations" Configuring the Inputs

▶ Paperless Recorder User's Manual (Electronic Manual) (IM 04L51B01-01EN)

▶ First Step Guide (This manual) (IM 04L51B01-02EN) "Basic Operations" Starting Measurement and Recording

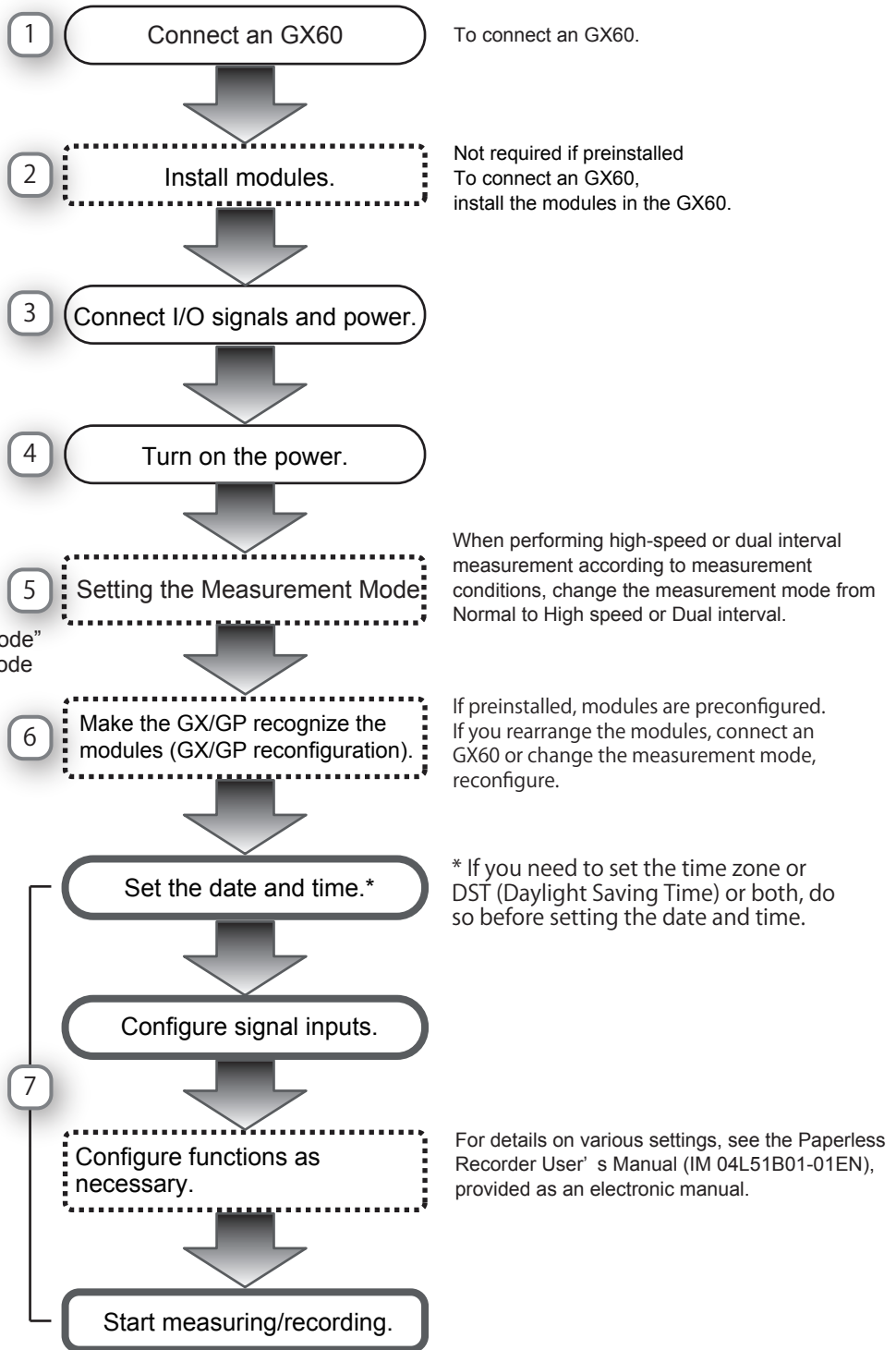

**1** **1** Install an expansion module (GX90EX) into the GX/GP.

9

GX90EX

GX10/GP10 : Slot 2  
GX20/GP20 : Slot 9

**2** GX60 address setting

Setting switch (DIP switch)

GX90EX

**3** Connect the LAN cable between GX/GP and GX60.

**1** Modules not installed

Ex GX/GP

Dummy covers are attached to empty slots (with screws).

\* Recommended tightening torque: 0.6 N·m

**2** Insert until a click is heard and fasten with screws.\*

**3** Modules installed (10 modules)

**3**

Ex GX/GP

Power inlet on the GP10/GP20/GX60 (Power inlet type)

**3**

GX60

**WARNING**

To prevent electric shock when wiring, make sure that the power supply is turned off.

**4**

Power switch

**4**

GX60

**5** Set the measurement mode

**6** Reconfiguration (Initialize)

Initialize Calibration

**7** Set the date and time\*. Configure input and functions.

Date/Time setting

Setting

**Start measuring/recording.**

**Recording stopped**

**Recording progress**

Alternates

Lit in blue Running (No alarm)

Lit in red Alarm activated

Off: Power off

To open, push the front door down and pull it toward you.

# Installation and Wiring

## Installation Location

Install the GX/GP indoors in an environment that meets the following conditions:

- If hazardous external voltage (30 V AC or 60 V DC or more) is applied to the output terminals of the GP10/GP20/GX60, be sure to install it in a location where people cannot touch the terminals carelessly or in a panel.
- The GX10/GX20 is designed to be installed in an instrumentation panel.
- This product is designed as open equipment under the CSA/UL/EN 61010-2-201 standards. In order to comply with these standards, install it as follows:
  - The GX10/GX20 is designed to be installed in an instrumentation panel.  
Install it in a location where people cannot touch the terminals carelessly.
  - To make the GP10/GP20 comply with the relevant standard, support the parts of the device other than the front-panel control area with an instrumentation panel or the like, and install it in a location where people cannot touch the terminals carelessly or in a panel.
  - Install the GX60/GM unit in a panel with a door.
  - The instrumentation panel or panel used for support must comply with CSA/UL/EN 61010-2-201 or must be at least IP1X (degrees of protection) and at least IK09.



### WARNING

**To make panel door lock for GX10/GX20 or install the GP/GX60 systems in a panel with a door or in a location where operator or any third person can not operate the power switch carelessly. When the power switch of GX/GP systems under operation be turned on or off carelessly, it may result the system down or injury. Careless operations can be avoided by applying the slide lock.**

- Well-ventilated location  
To prevent overheating, install the GX/GP in a well-ventilated location. For the panel cut dimensions when arranging multiple GXs, see the next page. When other instruments are installed next to the GX, follow the panel cut dimensions to provide adequate space around the GX. In the case of the portable type, we recommend that you provide at least 50 mm of space from the left, right, and top panels.

- Minimal mechanical vibrations  
Install the GX/GP in a location that has minimal mechanical vibrations. Installing the GX/GP in a location that is subject to large levels of mechanical vibration will not only put added stress on its components, it may also impede ordinary measurement.
- Level Location  
Install the GX/GP in a level location so that it is not slanted to the left or the right (however, the GX/GP can be inclined up to 30 degrees backward for panel mounting).

### Note

Condensation may form when moving the GX/GP from a low temperature or humidity environment to a high temperature or humidity environment, or when there is a sudden change in temperature. Temperature or humidity changes may also result in thermocouple measurement errors. In these kinds of circumstances, wait for at least an hour before using the GX/GP, to acclimate it to the surrounding environment.

The GP20 may tip over if it is tilted more than 10 degrees, front and back.

### Do Not Install the Instrument in the Following Places

- Outdoors
- In direct sunlight or near heat sources  
Install the GX/GP in a place that is near room temperature (23°C) and that is not subject to large temperature fluctuations. Placing the GX/GP in direct sunlight or near heat sources can cause adverse effects on the internal circuitry.
- Where an excessive amount of soot, steam, moisture, dust, or corrosive gases are present  
Soot, steam, moisture, dust, and corrosive gases will adversely affect the GX/GP. Avoid installing the GX/GP in such locations.
- Near strong magnetic field sources  
Do not bring magnets or instruments that produce electromagnetic fields close to the GX/GP. Operating the GX/GP near strong magnetic fields can cause measurement errors.
- Where the display is difficult to see  
The GX/GP uses an LCD screen, so it is difficult to view the display from an extreme angle. Install the GX/GP so that the user can view the display directly from the front.

## Installation Procedure



- Using more than the appropriate torque to tighten the screws can deform the case or damage the brackets.
- Be sure not to insert foreign objects or tools into the case through the mounting bracket holes.
- When you attach the rubber packing, be sure that no portion of it gets wedged between the GX and the panel. If the rubber packing is not attached properly, you will not be able to achieve sufficient dust proofing or waterproofing.

### Installation Procedure for the GX10/GX20

Use a steel panel that is 2 mm to 26 mm thick.

- 1 Insert the GX through the front of the panel.
- 2 Mount the GX to the panel using the included mounting brackets as described below.
  - Use two mounting brackets to support the top and bottom or the left and right sides of the case (remove the stickers that are covering the holes before you attach the brackets).
  - The recommended tightening torque for the mounting screws is 0.7 to 0.9 N•m.
  - Follow the procedure below to mount the GX to the panel.
    - First, attach the two mounting brackets and temporarily tighten the mounting screws.
    - Next, fix the GX in place by tightening the mounting screws with the appropriate torque. When the GX is approximately perpendicular to the panel, press the mounting brackets so that they are in contact with the case, and fully tighten the mounting screws.

#### Note

To achieve sufficient dust proofing and waterproofing, mount the GX in the middle of the panel cut out.

### Installation Procedure for the GX60

Use a steel panel that is at least 2 mm thick.

- 1 Make 6 holes in the panel for the six M4 screws.
- 2 Fix the unit in place by fastening M4 screws to the six mounting screw holes. The recommended tightening torque for the screws is 0.7 to 0.9N•m.

## External Dimensions and Panel Cut Dimensions

### GX20 External Dimensions

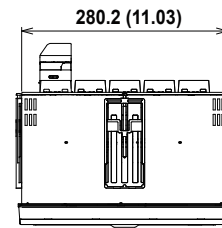

Unit: mm (approx. inch)  
Unless otherwise specified, tolerance is  $\pm 3\%$  (however, tolerance is  $\pm 0.3$  mm when below 10 mm).

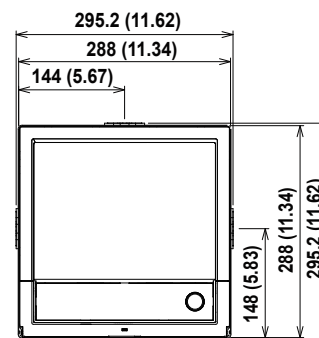

(Dimensions before attaching the mounting bracket)

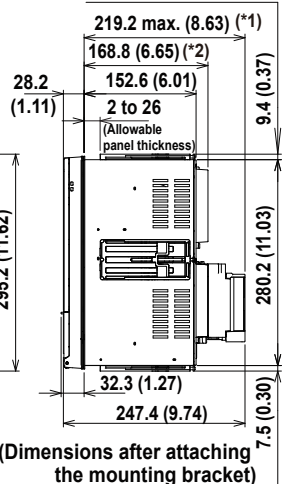

#### Panel cut dimensions

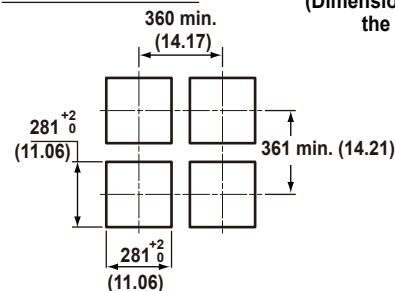

(Dimensions after attaching the mounting bracket)

- \*1: With modules
- \*2: Without modules

**GX10 External Dimensions**

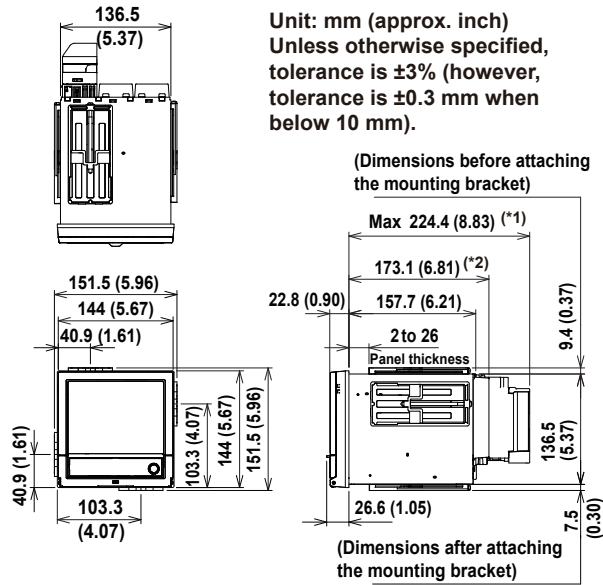

\*1: With modules  
\*2: Without modules

**Panel cut dimensions**

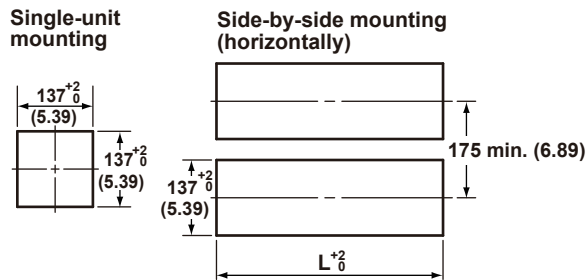

**Side-by side mounting (vertically; max. 3 units)**

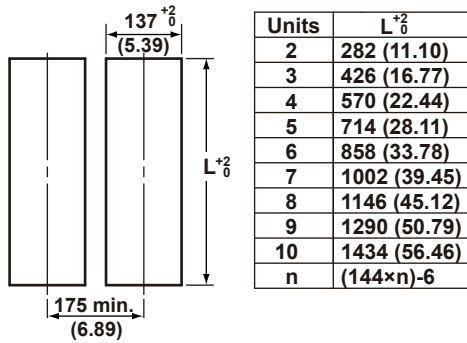

**GP20 External Dimensions**

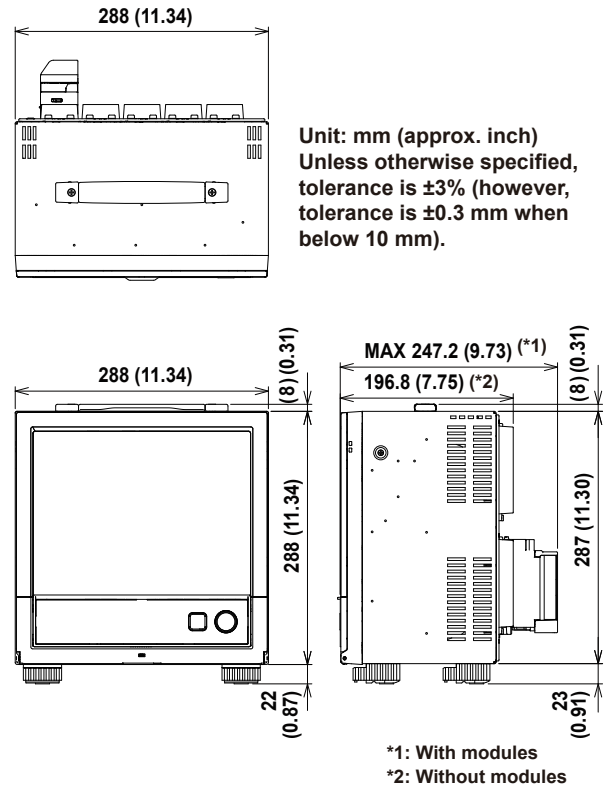

**GP10 External Dimensions**

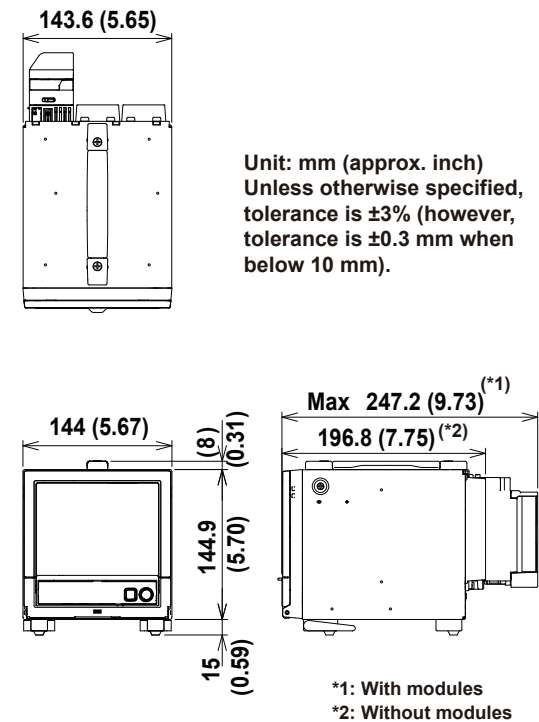

When using the stand, the GP10 will face 12 degrees upward.

**GX60 Dimensions**

Power supply terminal type

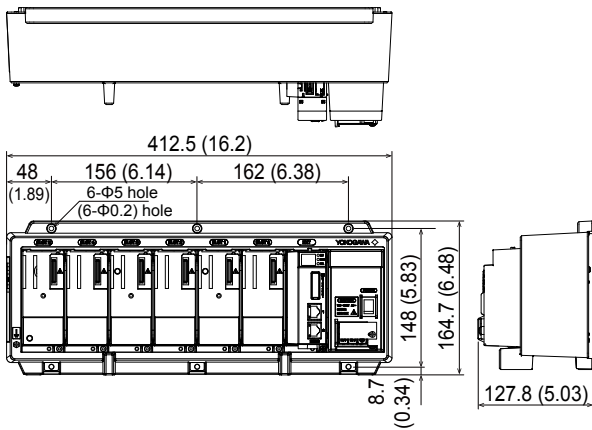

Power inlet type

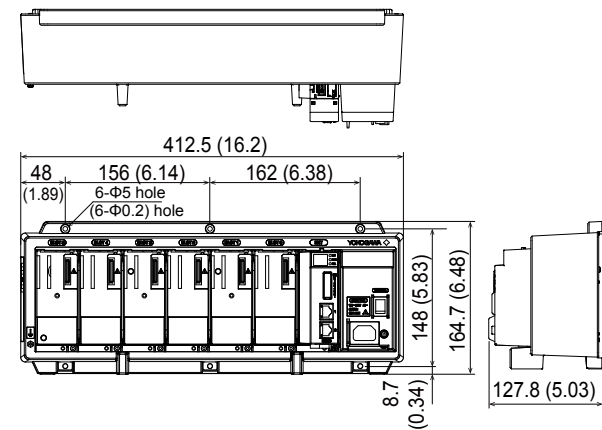

With modules

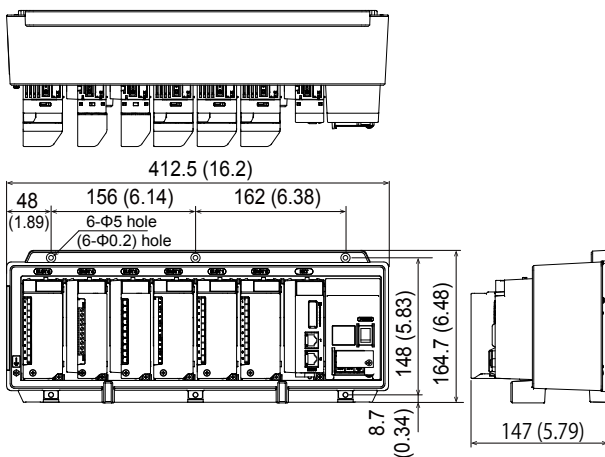

Unit: mm (approx. inch)

Unless otherwise specified, tolerance is  $\pm 3\%$  (however, tolerance is  $\pm 0.3$  mm when below 10 mm).

Mounting hole dimensions

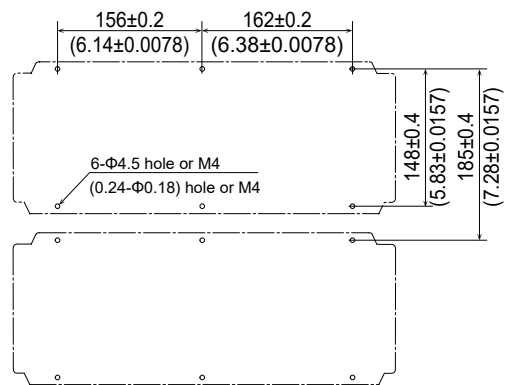

## Connect an GX60

### Installing an Expansion Module into the GX/GP

When installing an expansion module into the GX/GP or setting dipswitches, turn off the GX/GP and the GX60.

- 1 Install an expansion module into slot 9 or 2 of the GX/GP.
- 2 Set dipswitch 8 of the expansion module to "ON" (master).  
Set the unit number to 0.  
(Default: 0)

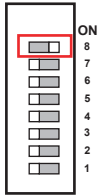

### Setting the Unit Number of the GX60

The factory default unit number of the expansion module is 0. Use dipswitches 1 to 4 to set the unit number (1 to 6).

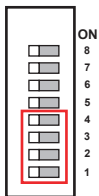

Unit number and dipswitch setting

Unit number	Dipswitch			
	1	2	3	4
6	OFF	ON	ON	OFF
5	ON	OFF	ON	OFF
4	OFF	OFF	ON	OFF
3	ON	ON	OFF	OFF
2	OFF	ON	OFF	OFF
1	ON	OFF	OFF	OFF
0 <sup>1</sup>	OFF	OFF	OFF	OFF

- 1 The factory default setting. Unit number "0" is reserved for the expansion module that is installed into the GX/GP.

### Fixing the Data Rate to 10 Mbps

To fix the data rate to 10 Mbps, set dipswitch 7 to "ON".

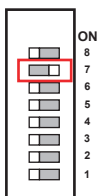

7-segment LED for 10 Mbps fixed mode



Dot indication

## Connect an GX60

Connect the expansion module installed in the GX/GP to the expansion modules of each expansion unit using Ethernet STP (shielded) cables.

Only cascaded connection is supported.

Maximum communication distance is 100 m. Distance extension through HUB connection or LAN repeaters is not possible.

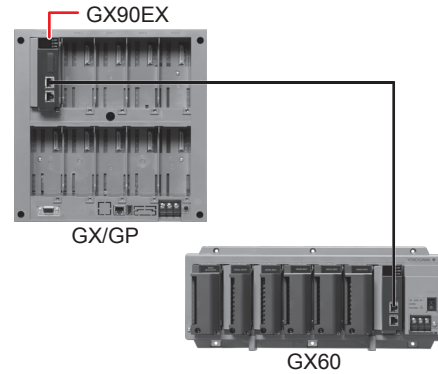

## Functions of Expansion Module Components

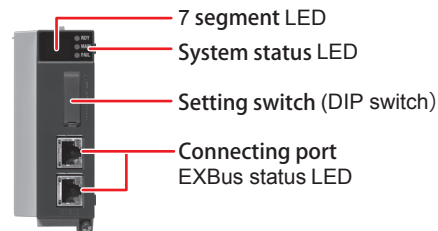

### 7 segment LED

Displays the unit number and operation errors of the GX/GP and GX60

- Unit number indication  
Displays the unit number (00 to 06).
- Operation error indication  
Displays error codes. Ex (where x is a one digit number or an alphabet letter) will blink. For details on error codes, see "Expansion Module Error Codes" in section 5.2.1, "Messages" of the User's Manual (IM 04L51B01-01EN).

- \* If an "Fx" indication is displayed, servicing is necessary. Contact your nearest YOKOGAWA dealer for repairs.

### System Status Display LED

Three LEDs indicate the operating status of the expansion module.

Status display LED	Color	Description
RDY	Green	Illuminates during normal operation. Turns off when during a failure.
MAIN	Green	Illuminates during master I/O expansion operation.
FAIL	RED	Illuminates during an error.



### Setting Switches (Dipswitches)

Use the dipswitches to set the unit number of the GX60, 10 Mbps fixed mode, and operation mode.

#### Dipswitch settings

Dipswitch	Description
8	Switches between master I/O expansion and slave I/O expansion mode
7	10 Mbps/100Mbps
6	Always OFF (cannot be changed)
5	Always OFF (cannot be changed)
4	For unit number
3	
2	
1	

### Port

The port is used to connect the GX60 to the GP/GX. Only cascaded connection is supported.

## Installing and Removing I/O Modules

### Installing a Module

- As shown below, insert the module into the GX/GP slot and the GX60 slot.
- Push the module in until you hear a click. Then, fasten the screw at the bottom section of the module.\*

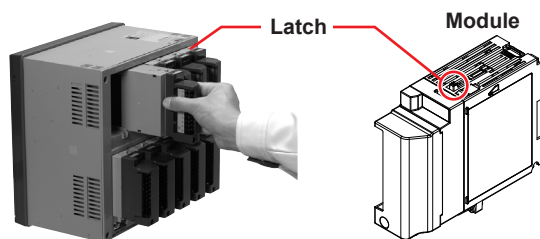

Ex. GX/GP

\* Recommended torque for tightening the screws: 0.6 N•m

### Removing a Module

- Loosen the screw at the bottom section of the module.
- While pressing down on the latch at the top of the module, pull the module out.

### Limit to the Number of GX/GP Main Unit Modules

- When GX90XA-04-H0 and GX90YA are included

GX10	GP10	GX20-1	GP20-1	GX20-2	GP20-2
No limit	No limit*	9	9	9	9

\* Up to two modules for 12 V DC models (power supply suffix code: 2)

- When GX90UT is included

GX10	GP10	GX20-1	GP20-1	GX20-2	GP20-2
No limit	No limit*	8	8	8	8

\* Up to two modules for 12 V DC models (power supply suffix code: 2)

### Limit on Modules

- Up to 10 modules consisting of GX90YD, GX90WD, and GX90UT can be installed into the system.
- One GX90WD module can be installed in a GX. One module can be installed in a GX60 (expandable I/O) and each GM sub unit.
- One GX90YA module can be installed in a GX10. Two modules can be installed in each of the GX20, GX60 (expandable I/O) and GM sub unit.
- Up to 10 GX90YA modules can be installed in a GX10/GX20-1 system and up to 12 in a GX20-2 system.
- If the measurement mode is High speed, only GX90XA-04-H0 (high-speed AI), GX90XD (DI), and GX90WD (DIO) are detected. DI and DIO are fixed to remote mode. Measurement and recording are not possible.
- If the measurement mode is Dual interval, GX90UT is not detected.

### Notes on Module Installation

- When the reference junction compensation of this product is used with the thermocouple input of a GX90XA-10-U2, GX90XA-10-L1, GX90XA-10-T1, GX90XA-10-V1, or GX90XA-04-H0, if the following module is installed to the right (slot with the smaller number) of the GX90XA module as seen from the GX rear panel, the reference junction compensation accuracy of that module may deviate from the guaranteed range (except when GX90XA-04-H0 is installed to adjacent slots).  
GX90XA-10-C1, GX90XA-04-H0, GX90WD, GX90YA, GX90UT
- On the GX20, when the reference junction compensation of this product is used with the thermocouple input of a GX90XA-10-U2, GX90XA-10-L1, GX90XA-10-T1, GX90XA-10-V1, or GX90XA-04-H0, if the following module is installed above, below, to the right, or to the left (slot with the smaller number) of the GX90XA module as seen from the GX rear panel, the reference junction compensation accuracy of that module may deviate from the guaranteed range.  
GX90YA, GX90UT

**Channel Names**

A channel name consists of a unit number, slot number, and channel number.

GX/GP: (Fixed) Channel name  
 GX60: 1 to 6

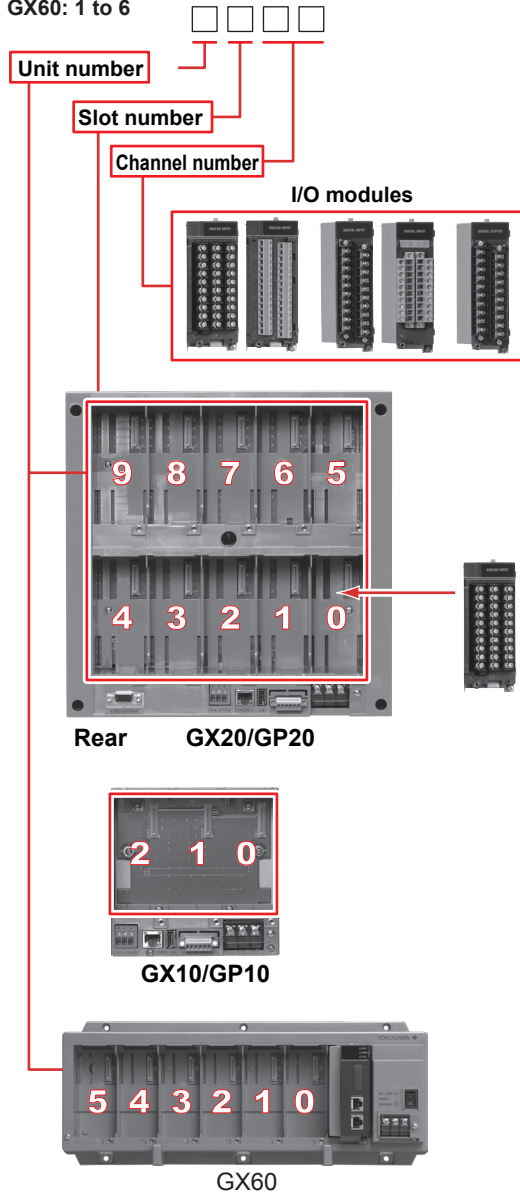

**Wiring**



- To prevent electric shock while wiring, make sure that the power supply is turned off.
- If a voltage of more than 30 VAC or 60 VDC is to be applied to the output terminals, use ring-tongue crimp-on lugs with insulation sleeves on all terminals to prevent the signal cables from slipping out when the screws become loose. Furthermore, use double-insulated cables (dielectric strength of 2300 VAC or more) for the signal cables on which a voltage of 30 VAC or 60 VDC or more is to be applied. For all other signal cables, use basic insulated cables (dielectric strength of 1390 VAC). To prevent electric shock, attach the terminal cover after wiring and make sure not to touch the terminals.
- Applying a strong tension to the input and output signal cables connected to the GX/GP may damage the cables or the GX/GP terminals. To avoid applying tension directly to the terminals, fix all cables to the rear of the mounting panel.
- To prevent fire, use signal cables with a temperature rating of 70°C or more.
- To avoid damage to the GX/GP, do not apply voltages that exceed the following values to the input terminals.

**GX90XA**

- Allowable input voltage:  $\pm 10$  V DC for TC/DC voltage (1 V range or less)/RTD/DI (Contact), DC mA  
 $\pm 60$  V DC for DC voltage (2 V to 50 V range), DI (voltage) input (except High-speed AI)  
 $\pm 120$  V DC for DC voltage (2 to 100 V range) input, DI (voltage) (High-speed AI)
- Common mode voltage:  $\pm 60$  VDC (under measurement category II conditions)  
 High-speed AI only  
 $\pm 300$  VAC rms (under measurement category II conditions)  
 High withstand voltage only  
 $\pm 600$  VAC rms /  $\pm 600$  VDC (under measurement category II conditions)

**GX90XD, GX90WD**

- Allowable input voltage: +10 VDC

**GX90XP**

- Allowable input voltage:  $\pm 10$  VDC

**GX90UT**

- Allowable input voltage:  $\pm 10$  V DC for TC/DC voltage (1 V range or less)/RTD/DI (Contact), DC mA  
 $\pm 60$  V DC for DC voltage (2 V range or more), DI (voltage)
- Common mode voltage:  $\pm 60$  VDC (under measurement category II conditions)

The GX/GP is an installation category II product.

### Precautions to Be Taken While Wiring

Take the following precautions when wiring the input/output signal cables.

- With a screw terminal, we recommend that you use a crimp-on lug with an insulation sleeve (M4 for power supply wiring, M3 for signal wiring).



Recommended signal wiring crimp-on lug      N1.25-MS3  
(JST Mfg. Co., Ltd.)

- When not using crimp-on lug with an insulation sleeve, use a signal wire with a finished outside diameter of  $\phi 5$  mm or less.
- With a clamp terminal, we recommend the following wire.

GX90XA  
Cross-sectional area      0.05 mm<sup>2</sup> to 1.5 mm<sup>2</sup> (AWG30 to 16)  
Stripped wire length      5 to 6 mm

GX90XD, GX90XP, GX90YA  
Cross-sectional area      0.2 mm<sup>2</sup> to 1.5 mm<sup>2</sup> (AWG24 to 16)  
Stripped wire length      9 to 10 mm

RS-422/485 (/C3 option)  
Cross-sectional area      0.2 mm<sup>2</sup> to 1.5 mm<sup>2</sup> (AWG24 to 16)  
Stripped wire length      6 to 7 mm

FAIL output/status output (/FL option)  
Cross-sectional area      0.33 mm<sup>2</sup> to 2.0 mm<sup>2</sup> (AWG22 to 14)  
Stripped wire length      10 to 11 mm

- Take measures to prevent noise from entering the measurement circuit.
  - Move the measurement circuit away from the power cable (power circuit) and ground circuit.
  - Ideally, the object being measured should not generate noise. However, if this is unavoidable, isolate the measurement circuit from the object. Also, ground the object being measured.
  - Shielded wires should be used to minimize the noise caused by electrostatic induction. Connect the shield to the ground terminal of the GX/GP as necessary (make sure you are not grounding at two points).
  - To minimize noise caused by electromagnetic induction, twist the measurement circuit wires at short, equal intervals.
  - Make sure to earth ground the protective ground terminal through minimum resistance.
- When wiring input/output signal cables, observe the minimum bend radius of the cables. For the minimum bend radius, use the specifications indicated by the input signal cable manufacture or six times the conductor diameter of the input/output signal cable, whichever is larger.
- When using internal reference junction compensation on the thermocouple input, take measures to stabilize the temperature at the input terminal.
  - Always use the terminal cover.
  - Do not use thick wires which may cause large heat dissipation (we recommend a cross sectional area of 0.5 mm<sup>2</sup> or less).
  - Make sure that the ambient temperature remains reasonably stable. Large temperature fluctuations can occur if a nearby fan turns on or off.

- Connecting the input wires in parallel with other devices can cause signal degradation, affecting all connected devices. If you need to make a parallel connection, then
  - Turn the burnout detection function off.
  - Ground the instruments to the same point.
  - Do not turn ON or OFF another instrument during operation. This can have adverse effects on the other instruments.
- RTDs cannot be wired in parallel.

### Wiring Procedure

A terminal cover is screwed in place on the I/O terminal block. A label indicating the terminal arrangement is affixed to the cover.

1. Turn off the GX/GP/GX60, and remove the terminal cover.
2. Connect the signal cables to the terminals.

Recommended torque for tightening the screws	Screw terminal (M3)	0.5 to 0.6 N•m
	Clamp terminal	GX90XA: 0.4 N•m GX90XD: 0.5 N•m GX90XP: 0.5 N•m

3. Attach the terminal cover and fasten it with screws. The appropriate tightening torque for the screws is 0.6 N•m.

### Inside dimension of M3 screw terminal block

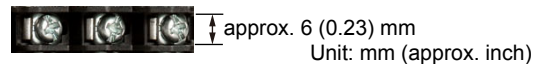

### Wiring Clamped Terminals

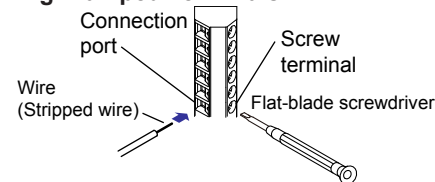

First, loosen the screw at the front using a flat-blade screwdriver. Insert the input signal wire into the slit on the left side of the terminal block, and fasten the screw at the front.

### Note

With a clamp terminal, if you use a single wire whose diameter is 0.3 mm or less, you may not be able to clamp the wire securely to the terminal. Take measures to securely clamp the wire such as by folding the conductor section that will be connected to the clamp terminal in half.

## Installation and Wiring

### Wiring to a GX90XA Analog Input Module

Universal/Low withstand voltage relay/  
Electromagnetic relay/Current (mA)/High withstand  
voltage type

#### Terminal Diagram

##### M3 screw terminal

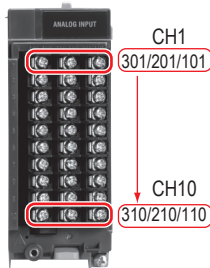

← Wiring direction

##### Clamp terminal

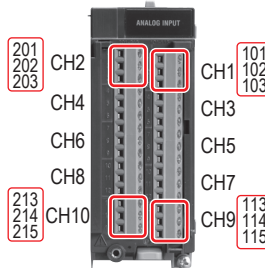

← Wiring direction

#### Wiring Diagram

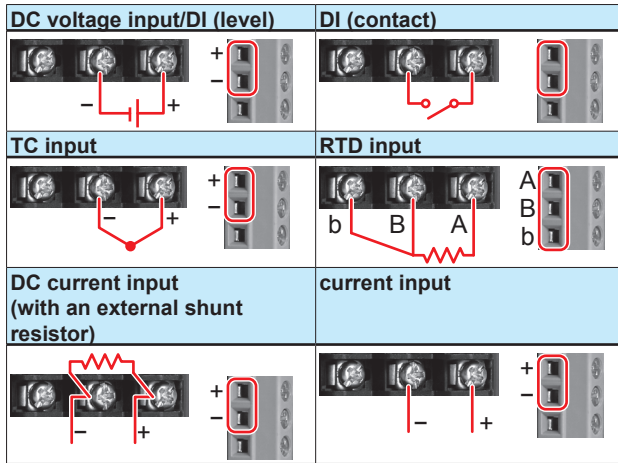

Type	Input type	Wiring
-U2	DC voltage, thermocouple (TC), resistance temperature detector (RTD), DI (voltage, contact), and DC current (by adding an external shunt resistor)	1, 2, 3, 4, 5
-C1	DC current (mA)	6
-L1	DC voltage, thermocouple (TC), DI (voltage, contact), and DC current (by adding an external shunt resistor)	1, 2, 3, 5
-T1		
-V1		

#### Terminal Arrangement

##### M3 screw terminal

CH No.	Term. No.	Symbol	Term. No.	Symbol	Term. No.	Symbol
CH1	301	b <sup>1</sup>	201	-/B	101	+/A
CH2	302	b <sup>1</sup>	202	-/B	102	+/A
CH3	303	b <sup>1</sup>	203	-/B	103	+/A
CH4	304	b <sup>1</sup>	204	-/B	104	+/A
CH5	305	b <sup>1</sup>	205	-/B	105	+/A
CH6	306	b <sup>1</sup>	206	-/B	106	+/A
CH7	307	b <sup>1</sup>	207	-/B	107	+/A
CH8	308	b <sup>1</sup>	208	-/B	108	+/A
CH9	309	b <sup>1</sup>	209	-/B	109	+/A
CH10	310	b <sup>1</sup>	210	-/B	110	+/A

#### Clamp terminal

CH No.	Term.No.	Symbol	CH No.	Term.No.	Symbol
CH2	201	+/A	CH1	101	+/A
	202	-/B		102	-/B
	203	b <sup>1</sup>		103	b <sup>1</sup>
CH4	204	+/A	CH3	104	+/A
	205	-/B		105	-/B
	206	b <sup>1</sup>		106	b <sup>1</sup>
CH6	207	+/A	CH5	107	+/A
	208	-/B		108	-/B
	209	b <sup>1</sup>		109	b <sup>1</sup>
CH8	210	+/A	CH7	110	+/A
	211	-/B		111	-/B
	212	b <sup>1</sup>		112	b <sup>1</sup>
CH10	213	+/A	CH9	113	+/A
	214	-/B		114	-/B
	215	b <sup>1</sup>		115	b <sup>1</sup>

- There are no symbol indications for the electromagnetic relay, current (mA), low withstand voltage relay or high withstand voltage type.
  - The RTD b terminal is connected internally.

#### High-speed universal

##### Terminal Diagram

##### M3 screw terminal

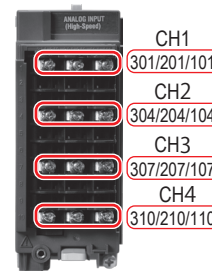

← Wiring direction

##### Clamp terminal

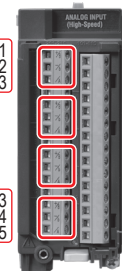

← Wiring direction

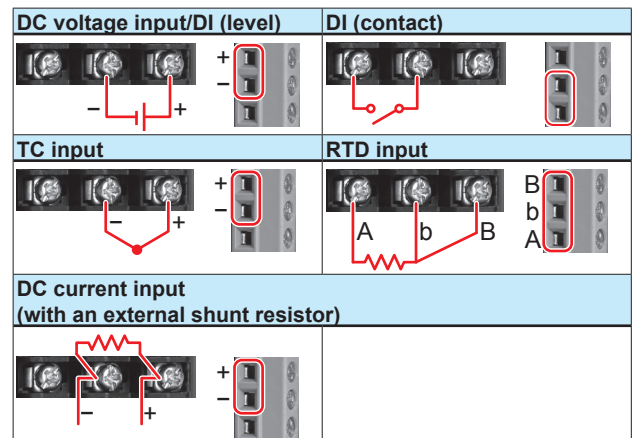

\* Be careful because the DI wiring is different between level and contact.



## Installation and Wiring

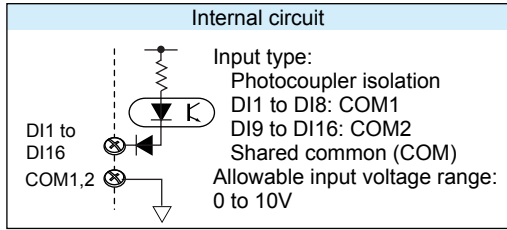

Note: Do not apply voltage outside the allowable input voltage range across input terminals. Doing so can cause a malfunction.

### Wiring to a GX90YD Digital Output Module Terminal Diagram

M3 screw terminal

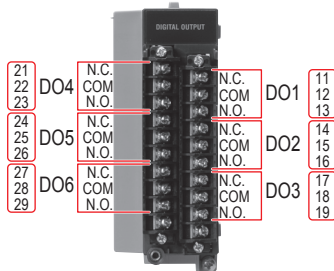

← Wiring direction

### Terminal Arrangement

DO No.	Term. No.	Symbol	DO No.	Term. No.	Symbol
DO4	21	NC	DO1	11	NC
	22	COM		12	COM
	23	NO		13	NO
DO5	24	NC	DO2	14	NC
	25	COM		15	COM
	26	NO		16	NO
DO6	27	NC	DO3	17	NC
	28	COM		18	COM
	29	NO		19	NO
	30	-		20	-

### Wiring to a GX90WD Digital Input /Output Module Terminal Diagram

M3 screw terminal

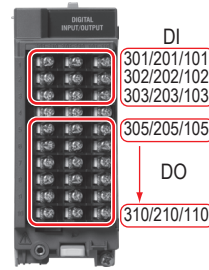

← Wiring direction

### Terminal Arrangement

CH No.	Term. No.	Symbol	Term. No.	Symbol	Term. No.	Symbol
DI1 to DI8	301	DI3	201	DI2	101	DI1
	302	DI6	202	DI5	102	DI4
	303	DICOM	203	DI8	103	DI7
-	304	-	204	-	104	-
DO1	305	DO1NO	205	DO1COM	105	DO1NC
DO2	306	DO2NO	206	DO2COM	106	DO2NC
DO3	307	DO3NO	207	DO3COM	107	DO3NC
DO4	308	DO4NO	208	DO4COM	108	DO4NC
DO5	309	DO5NO	209	DO5COM	109	DO5NC
DO6	310	DO6NO	210	DO6COM	110	DO6NC

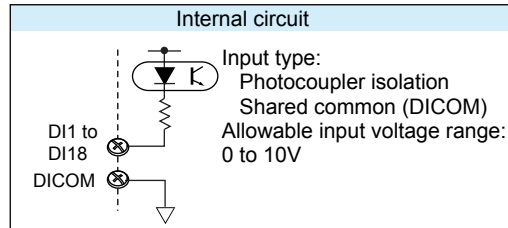

Note: Do not apply voltage outside the allowable input voltage range across input terminals. Doing so can cause a malfunction.

### Wiring to a GX90XP Pulse Input Module Terminal Diagram

M3 screw terminal

Clamp terminal

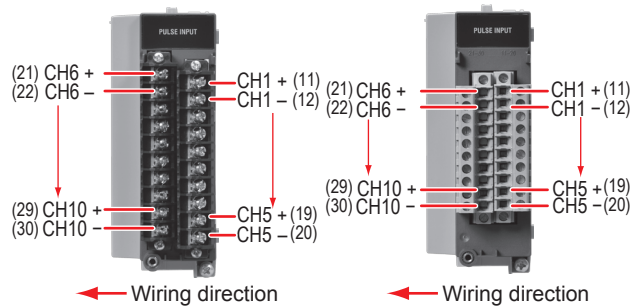

Terminal Arrangement

Term. No.	Symbol	Term. No.	Symbol
21	CH6 +	11	CH1 +
22	CH6 -	12	CH1 -
23	CH7 +	13	CH2 +
24	CH7 -	14	CH2 -
25	CH8 +	15	CH3 +
26	CH8 -	16	CH3 -
27	CH9 +	17	CH4 +
28	CH9 -	18	CH4 -
29	CH10 +	19	CH5 +
30	CH10 -	20	CH5 -

Negative terminal (common) potential shared

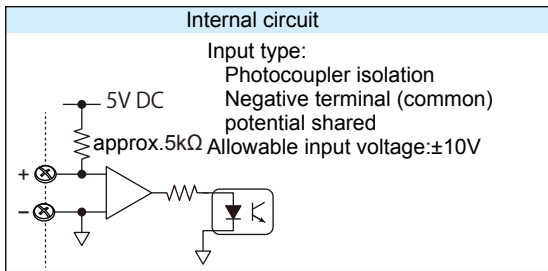

Note: Do not apply voltage outside the allowable input voltage range across input terminals. Doing so can cause a malfunction.

Wiring to a GX90YA Analog Output Module

Terminal Diagram

M3 screw terminal

Clamp terminal



← Wiring direction

← Wiring direction

Terminal Arrangement

Term. No.	Symbol
11	CH1 +
12	CH1 -
13	CH2 +
14	CH2 -
15	CH3 +
16	CH3 -
17	CH4 +
18	CH4 -
19	Not Used
20	Not Used

Wiring to a GX90UT PID Control Module

Terminal Diagram

M3 screw terminal



- 301/201/101
- 302/202/102
- 303/203/103
- 304/204/104
- 305/205/105
- 306/206/106
- 307/207/107
- 308/208/108
- 209/109
- 210/110

← Wiring direction

Analog Input

DC voltage input/DI (level)	DI (contact)
TC input	RTD input
DC current input (with an external shunt resistor)	

\* Be careful because the DI wiring is different between level and contact.

Analog Output

DC current output, voltage pulse, 15 V DC loop power supply

Terminal Diagram

Term. No.	Symbol	Term. No.	Symbol	Term. No.	Symbol
301	DI3	201	DI2	101	DI1
302	DI6	202	DI5	102	DI4
303	DICOM	203	DI8	103	DI7
304	DO3	204	DO2	104	DO1
305	DO6	205	DO5	105	DO4
306	DO-COM	206	DO8	106	DO7
307	AI1(/A)	207	AI1(-/b)	107	AI1(+/B)
308	AI2(/A)	208	AI2(-/b)	108	AI2(+/B)
309	Not Used	209	AO1(-)	109	AO1(+)
310	Not Used	210	AO12(-)	110	AO2(+)

\* Empty terminals may not be used





### Connecting to the Ethernet Port

#### Checking the Connection and Communication Status

You can use the indicators that are located above the Ethernet port to check the connection status of the Ethernet interface.

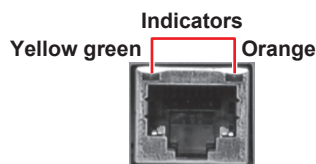

Indicator	Connection Status of the Ethernet Interface
Lit (yellow-green)	The Ethernet link is established.
Off (yellow-green)	The Ethernet link is not established.
Blinking (yellow-green)	Receiving data
Lit (orange)	Connected at 100 Mbps
Off (orange)	Connected at 10 Mbps

### Wiring the Power Supply

Use a power supply that meets the following conditions:

Item	Condition (Not /P1)	Condition (/P1)
Rated supply voltage	100 to 240 VAC	24 VDC/AC
Allowable power supply voltage range	GX/GP: 90 to 132 VAC, 180 to 264 VAC GX60: 90 to 132 VAC, 180 to 240 VAC	21.6 V to 26.4 VDC/AC
Rated power supply frequency	50/60 Hz	50/60 Hz (for AC)
Permitted power supply frequency range	50/60 Hz ± 2%	50/60 Hz ± 2% (for AC)
Maximum power consumption 100 VAC (/P1: 24 VDC)	GX10/GP10: 48 VA GX20/GP20: 90 VA GX60: 40VA	GX10: 24 VA GX20: 48 VA
Maximum power consumption 240 VAC (/P1: 24 VAC)	GX10/GP10: 60 VA GX20/GP20: 110 VA GX60: 55VA	GX10: 42 VA GX20: 76 VA

#### Note

Do not use a supply voltage of 132 to 180 VAC, as this may have adverse effects on the measurement accuracy.

#### GP10 Power Supply Suffix Code: 2

Item	Condition
Rated supply voltage	12 VDC
Allowable power supply voltage range	10 V to 20 VDC
Maximum power consumption	26 VA

### Precautions to Be Taken When Wiring the Power Supply (GX10/GX20/GX60)

Make sure to follow the warnings below when wiring the power supply. Failure to do so may cause electric shock or damage to the instrument.



**WARNING**

- To prevent electric shock, ensure that the power supply is turned off.
- To prevent fire, use 600 V PVC insulated wires (AWG20 to AWG16; JISC3307) or wires or cables with equivalent or better performance.
- Make sure to earth ground the protective ground terminal through minimum resistance before you turn on the power.
- Use crimp-on lugs (designed for 4 mm screws) with insulation sleeves to connect both the power cord and the protective ground.
- To prevent electric shock, be sure to close the transparent cover for the power supply wires.
- Provide a power switch (double-pole type) on the power supply line to separate the GX/GP from the main power supply. Use labels to indicate that this switch is for cutting off the power supply to the GX/GP and to indicate ON and OFF.  
**Switch specifications**  
 Steady-state 1 A or higher (Not /P1), current rating 3 A or higher (/P1)  
 Inrush 60 A or higher (Not /P1), current rating 70 A or higher (/P1)  
 Must comply with IEC60947-1 and IEC60947-3.
- Do not add a switch or fuse to the ground line.

### Wiring Procedure (GX10/GX20/GX60)

1. Turn off the GX power supply, and then remove the transparent power supply terminal cover.
2. Connect the power cord and the protective ground cord to the power supply terminal. Use ring-tongue crimp-on lugs (for M4 screws) with insulation sleeves. The appropriate tightening torque for the screws is 1.4 to 1.5 N·m.

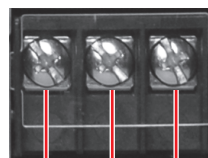

L(+) N(-) Protective ground

3. Attach the transparent power supply terminal cover, and fasten it with screws.

### Precautions to Be Taken When Connecting the Power Supply (GP10/GP20/GX60)

Make sure to follow the warnings below when connecting the power supply. Failure to do so may cause electric shock or damage to the instrument.



- Before connecting the power cord, ensure that the source voltage matches the rated supply voltage of the instrument and that it is within the maximum rated voltage range of the provided power cord.
- Connect the power cord after checking that the power switch of the instrument is turned OFF.
- To prevent electric shock and fire, be sure to use a power cord purchased from Yokogawa Electric Corporation.
- Make sure to connect protective earth grounding to prevent electric shock. Insert the power cord into a grounded three-prong outlet.
- Do not use an extension cord without protective earth ground. If you do, the instrument will not be grounded.

### Connection Procedure

1. Check that the GP's power switch is off.
2. Connect the supplied power cord plug to the power inlet on the rear panel of the GP or front panel of the GX60.



3. Ensure that the source voltage is within the maximum rated voltage range of the provided power cord. Then, connect the other end of the cord to the outlet. Use a grounded three-prong outlet.

### Precautions to Be Taken When Connecting the Power Supply (GP10 Power supply Suffix Code: 2)

Make sure to follow the warnings below when connecting the power supply. Failure to do so may cause damage to the instrument.



- Wire the power cable to the power supply terminal, making sure that the polarity is correct.
- Connect the power cables after checking that the power switch of the instrument is turned OFF.
- Using other wires may cause abnormal heating or fire.

### Wiring Procedure (GP10 Power supply Suffix Code: 2)

1. Turn off the GP power supply, and then remove the transparent power supply terminal cover.
2. Wire the power cable to the power supply terminal, making sure that the polarity is correct. Use ring-tongue crimp-on lugs (for M4 screws) with insulation sleeves. The appropriate tightening torque for the screws is 1.4 to 1.5 N•m. Use 600 V PVC insulated wires (AWG20 to AWG16; JISC3307) or wires or cables with equivalent or better performance.

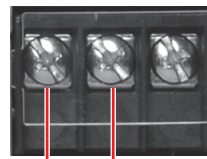

(+) (-)

3. Attach the transparent power supply terminal cover, and fasten it with screws.

# Basic Operation

## Turning the Power On and Off



**WARNING**

To make panel door lock for GX10/GX20 or install the GP/GX60 systems in a panel with a door or in a location where operator or any third person can not operate the power switch carelessly. When the power switch of GX/GP systems under operation (control in progress) be turned on or off carelessly, it may result the system down or injury. Be careful to operate the power switch on or off. Careless operations can be avoided by applying the slide lock.

### Turning the Power On



**CAUTION**

Check the following points before turning on the power switch.

- The power cord or wires are connected properly to the GX/GP and GX60.
- The GX/GP is connected to the correct power supply.

If the input wiring is connected in parallel with another instrument, do not turn on or off the GX/GP/GX60 or other instrument during operation. If you do, measured values may be affected.

### GX/GP

- 1 Open the front door.
- 2 Turn on the power switch.  
A self-test takes place for a few seconds, and then the operation screen appears.

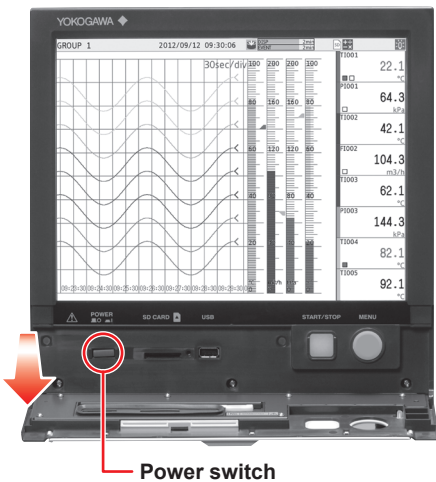

- 3 Close the front door.

### GX60

Turn on the power switch.



- If nothing appears on the display even when you turn on the power switch, turn off the power switch, and check the wiring and supply voltage. If, after checking these items, the GX/GP still fails to start when you turn on the power switch, it may be malfunctioning. Contact your nearest Yokogawa dealer for repairs.
- If an error message appears on the screen, take measures according to the information in chapter 5, “Troubleshooting” in the GX/GP User’s Manual.
- After you turn on the power switch, allow the GX/GP to warm up for at least 30 minutes before starting a measurement.

### Turning the Power Off



**CAUTION**

Check the following points before turning off the power switch.

- The external storage medium is not being accessed (the yellow-green LED is not blinking).

### GX/GP

- 1 Open the front door.
- 2 Turn off the power switch.
- 3 Close the front door.

### GX60

Turn off the power switch.

## Setting and Removing SD Memory Cards

### Setting a SD Memory Card

- 1 Open the front door.
- 2 Insert an SD memory card into the card slot.



### Removing the SD Memory Card

- 1 Press MENU.
- 2 Tap the media eject icon.

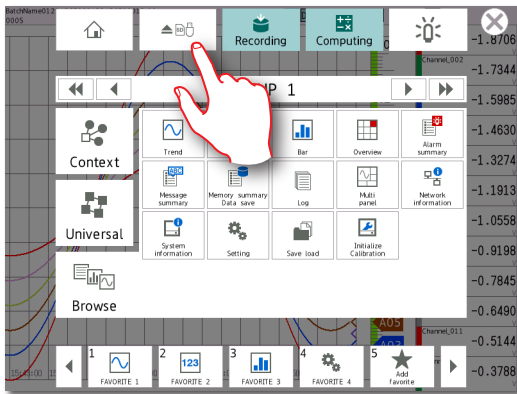

- 3 On the screen for selecting the type of media, tap SD.
- 4 Remove the SD memory card.

Operation complete

## Viewing the Operation Screen (Trend)

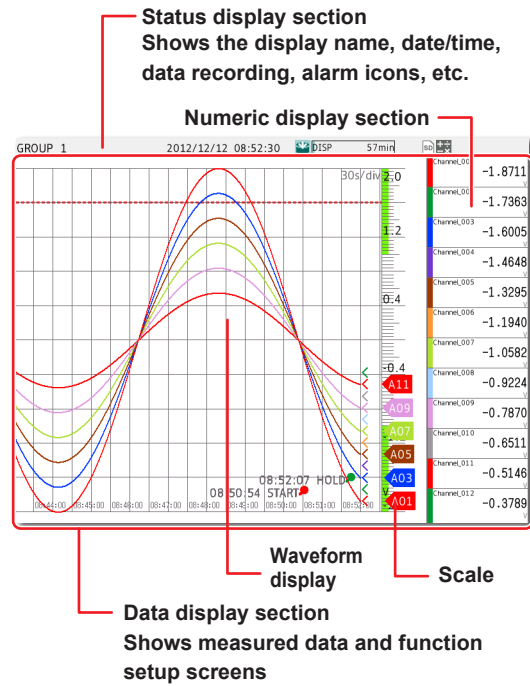

### Status Display Section

**Date and time**

**Recording status icon**

Recording in progress

Recording stopped

**Data type**

DISP: Display data

EVENT: Event data

**Recording progress**

Displays the progress using a green bar graph. The frame indicates the saving interval (display data) or data length (event data).

Internal memory error

**Control status icon**

Control in progress

Control stopped

**Display name or group name**

#### When using the batch function

BatchName01234567890123456789012-000001 2012/12/12 10:14:07

#### When using the login function

User Name012345678901 2012/12/12 10:17:54

#### When using the login and batch functions

BatchName01234567890123456789012-000002 2012/12/12 10:18:44

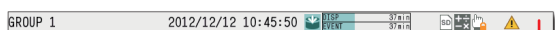

**SD memory card icon**

- Remaining memory space 50% or more
- Remaining memory space 50% or less
- Remaining memory space 10% or less
- External medium error

**Math icon (/MT option)**

- Gray icon: Computation started
- Yellow icon: Computation data dropout occurred

**Status icon**

- The condition assigned to instrument information output is occurring.
- Operation lock is enabled.
- E-mail transmission is enabled.

**Alarm icon**

- Displayed when any alarm is activated.

**Lit in red** Alarm activated.

**Blinking in red** Alarm indication set to hold. Alarms are currently activated, and some alarms have not been acknowledged.

**Blinking in gray** Alarm indication set to hold. All alarms have been cleared after alarms have occurred, but some alarms have not been acknowledged.

## Displaying the Menu Screen

To change the display between various setup screens and operation screens, display the menu screen.

- 1 Press **MENU**.  
The menu screen appears.

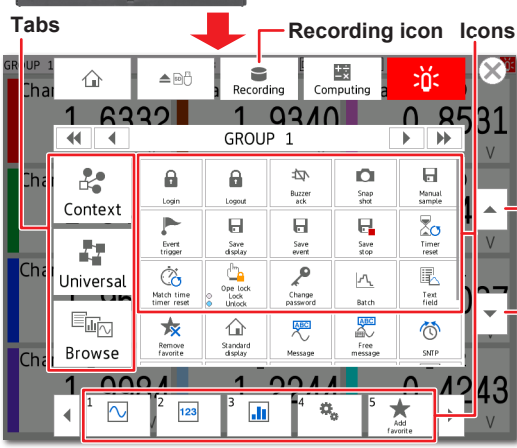
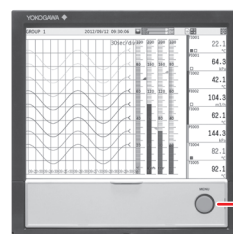

Scrolls the menu in the tab  
(These appear when the number of icons exceeds the maximum number that can be displayed.)

## Setting the Date and Time\*

\* If you need to set the time zone or DST (Daylight Saving Time) or both, do so before setting the date and time.

**Path** MENU key > Browse tab > Setting > Setting menu > System settings > Time basic settings

Set the date using the calendar and the time.

**Path** MENU key > Universal tab > Date/Time settings

- 1 Tap the Date tab.
- 2 Set the month and day with the switch icons.

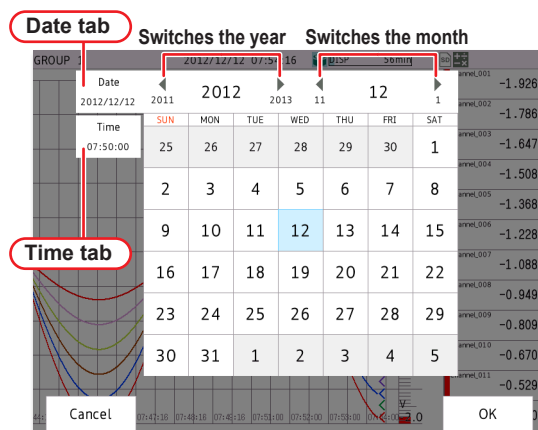

## Basic Operation

- 3 Tap the Time tab.
- 4 Enter the time using the keyboard, and tap **OK**.  
The time is set.

**Operation complete**

## Configuring the Inputs

For channel 1 (0001) of slot 0, set thermocouple type T, 0 to 200°C.

**Path** MENU key > Browse tab > Setting > Setting menu > AI channel settings > Range

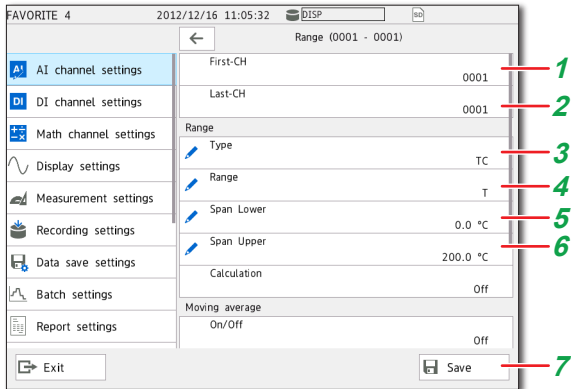

- 1 Tap **First-CH** > 0001.
- 2 Check that **Last-CH** is 0001.
- 3 Tap **Type** > TC.
- 4 Tap **Range** > T.
- 5 Tap **Span Lower**, and enter 0.0.
- 6 Tap **Span Upper**, and enter 200.0.
- 7 Tap **Save**.

**Operation complete**

## Starting Measurement and Recording

- 1 Press **MENU**.  
The menu screen appears.

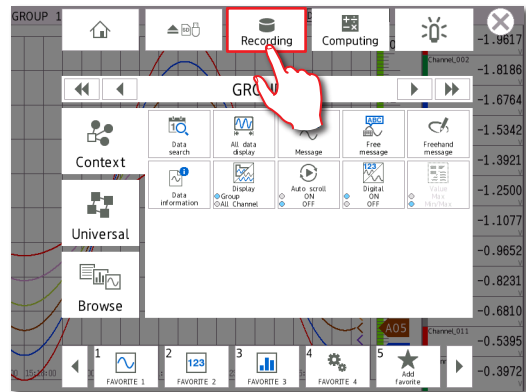

- 2 Tap the **Recording** icon.  
The record start screen appears.
- 3 Tap **Record**.  
Recording starts. The recording status icon in the status display section changes to recording in progress.

**Operation complete**

You can also start recording with the **START/STOP** key.

You can stop recording in the same way that you start recording.

## Switching between Operation Screens

- 1 Press **MENU**.  
The menu screen appears.

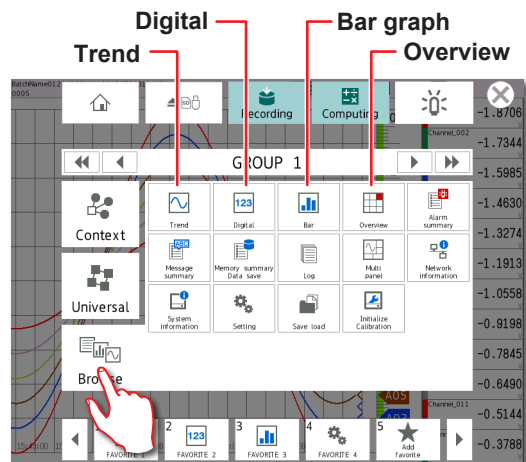

- 2 Tap the **Browse** tab.
- 3 Tap the icon of the display that you want to change to.

**Operation complete**

## Saving Data to USB Memory

- 1 Set the USB memory.  
The Media operation screen appears.
- 2 Tap the **Memory save Data save** icon.  
The Memory summary / Save screen appears.
- 3 Press **MENU**.  
The menu screen appears.
- 4 Tap the **Context** tab.  
Each data save icon appears.

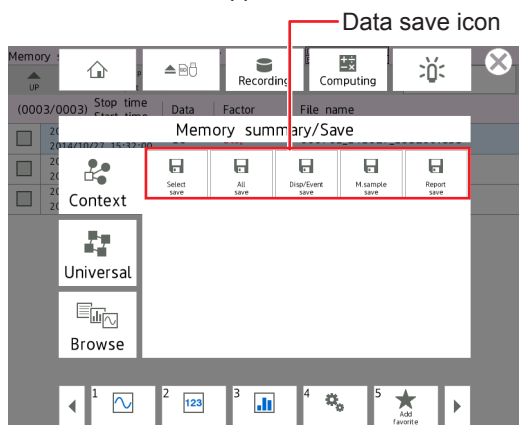

- 5 Tap data save icon to save.  
The data save screen appears.
- 6 Select the **USB**, and tap **OK**.  
The data is save to USB memory.

**Operation complete**

## Switching the Quick Settings (GP only)

A minimal setup menu for data collection is displayed.

**Path** MENU key > Browse tab > Setting >

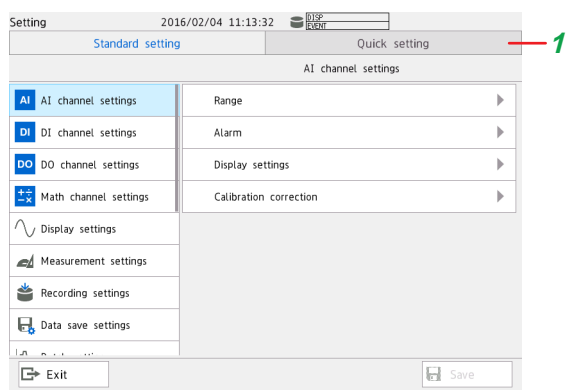

- 1 Tap the **Quick setting** tab.  
Setting menu of the quick setting is displayed.

**Operation complete**

This section explains how to change various settings. Before you change settings, stop recording and computation.

## Advanced Operation (Various settings and operation)

### Setting Measurement and Recording Conditions

Configuring the type of data to record to display data, the scan interval to 2 s, and the trend interval to 1 min.

#### Setting the Type of Data to Record

**Path** MENU key > Browse tab > Setting > Setting menu > Recording Settings > Basic settings

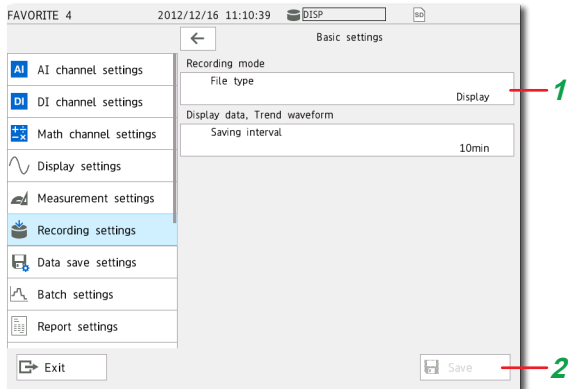

- 1 Tap File type > Display.
- 2 Tap Save.

You can set the file type to record only the data that suits your purpose. For example, you can record detailed data or record data only when alarms occur. For details, see the User's Manual (IM 04L51B01-01EN).

#### Setting the Scan Interval

**Path** MENU key > Browse tab > Setting > Setting menu > Measurement settings > Scan interval

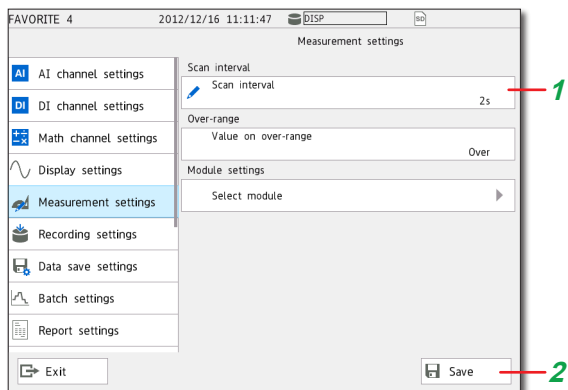

- 1 Tap Scan interval > 2s.
- 2 Tap Save.

Operation complete

#### Setting the Trend Interval

**Path** MENU key > Browse tab > Setting > Setting menu > Display settings > Trend interval

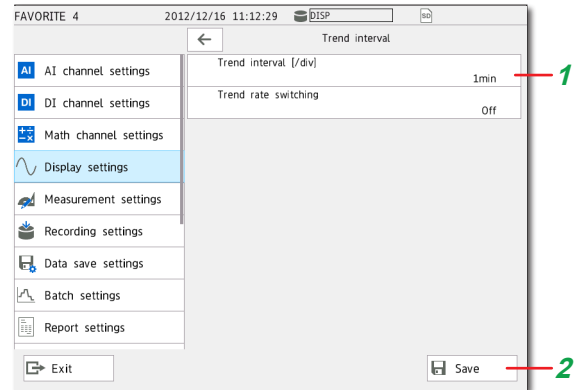

- 1 Tap Trend interval [div] > 1 min.
- 2 Tap Save.

Operation complete

### Setting Alarms

On channel 1 of slot 0, set the high limit alarm at the alarm value of 150°C.

**Path** MENU key > Browse tab > Setting > Setting menu > AI channel settings > Alarm

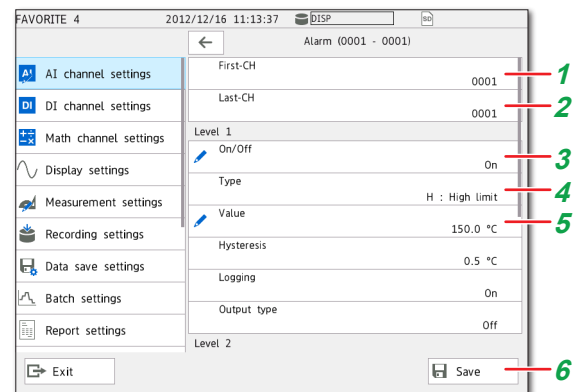

- 1 Tap First-CH > 0001.
- 2 Check that Last-CH is 0001.
- 3 Tap Level1 > On.
- 4 Tap Type > H.
- 5 Tap Value, and enter 150.0.
- 6 Tap Save.

Operation complete



## Alarm DO output

Alarms are transmitted via DO output to DO channel 1 of slot 1. (A DO output module is required.)

Configure the following settings in the alarm settings (see "Setting Alarms").

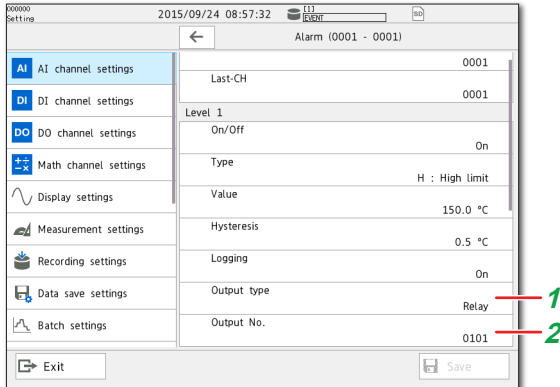

- 1 Tap **Output type** > **Relay**.
- 2 Tap the **Output No.**, and enter 0101.

**Path** MENU key > Browse tab > Setting > Setting menu > DO channel settings > Range

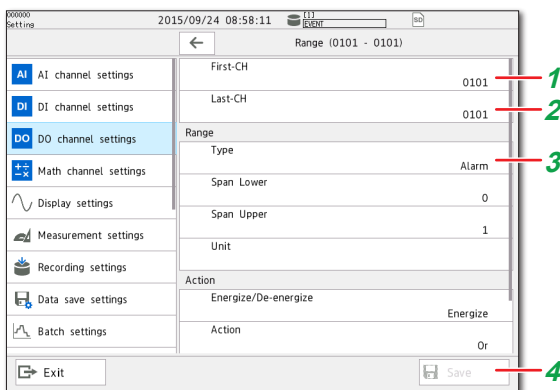

- 1 Tap **First-CH** > **0101**.
- 2 Check that **Last-CH** is **0101**.
- 3 Tap **Range Type** > **Alarm**.
- 4 Tap **Save**.

**Operation complete**

## Using the Scaling Function (Measuring a flow meter)

On channel 1 of slot 1 (0101), measure the input signal ranging from 1 to 5 VDC as 0.0 to 100.0 m<sup>3</sup>/h.

**Path** MENU key > Browse tab > Setting > Setting menu > AI channel settings > Range

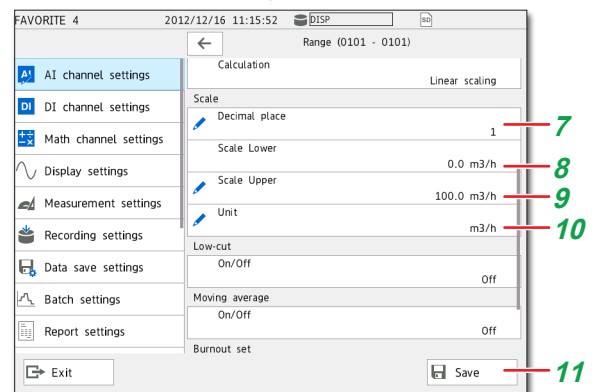
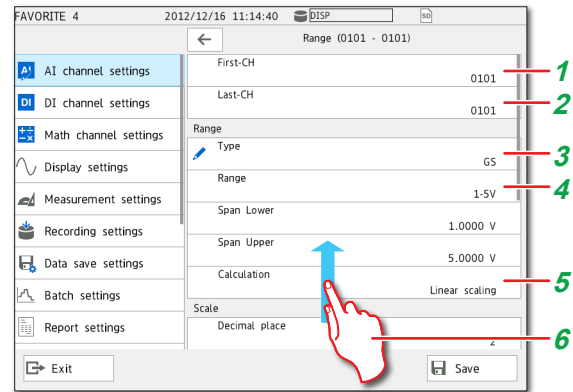

- 1 Tap **First-CH** > **0101**.
- 2 Check that **Last-CH** is **0101**.
- 3 Tap **Type** > **GS**.
- 4 Tap **Range** > **1-5V**.
- 5 Tap **Calculation** > **Linear scaling**.
- 6 Drag the screen up. Show the setting parameters off the screen at the bottom.
- 7 Tap **Decimal place** > **1**.
- 8 Tap **Scale Lower**, and enter 0.0.
- 9 Tap **Scale Upper**, and enter 100.0.
- 10 Tap **Unit**, and enter m3/h.
- 11 Tap **Save**.

**Operation complete**

## Using the Scaling Function (Measuring a temperature)

On channel 1 of slot 0 (0001), measure the input signal ranging from 0 to 5 VDC as 0.0 to 600.0 °C.

**Path** MENU key > Browse tab > Setting > Setting menu > AI channel settings > Range

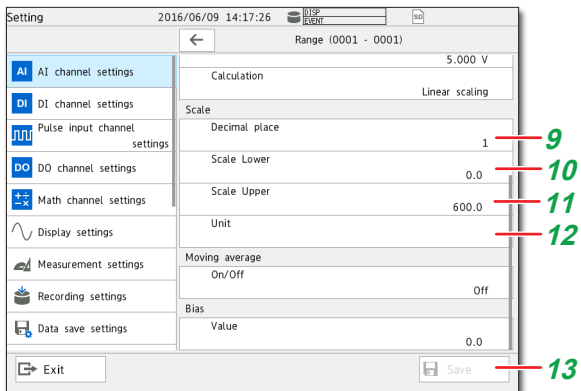
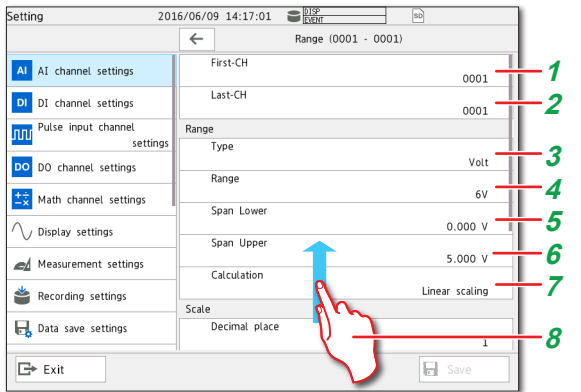

- 1 Tap **First-CH** > 0001.
- 2 Check that **Last-CH** is 0001.
- 3 Tap **Type** > Volt.
- 4 Tap **Range** > 6V.
- 5 Tap **Span Lower**, and enter 0.000.
- 6 Tap **Span Upper**, and enter 5.000.
- 7 Tap **Calculation** > Linear scaling.
- 8 Drag the screen up.  
Show the setting parameters off the screen at the bottom.
- 9 Tap **Decimal place** > 1.
- 10 Tap **Scale Lower**, and enter 0.0.
- 11 Tap **Scale Upper**, and enter 600.0.
- 12 Tap **Unit** >, and enter °C.
- 13 Tap **Save**.

Operation complete

## Registering and Deleting Favorite Screens

You can register displays that you use frequently as favorite screens and display them with easy operation. You can register up to 20 displays.

### Registering a Favorite Screen

- 1 Show the display that you want to register as a favorite screen.
- 2 Press **MENU**.  
The menu screen appears.

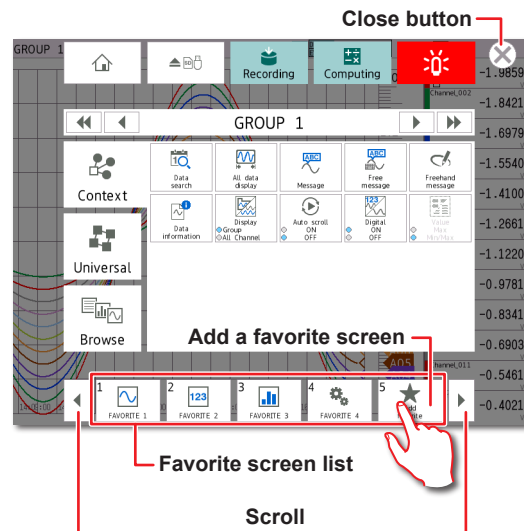

- 3 Tap **Add favorite**.  
A confirmation screen appears.
- 4 Tap **Favorite name**, and enter the name.
- 5 Tap **OK**.  
The display is registered.
- 6 Tap the **Close** icon.  
The screen closes.

Operation complete

### Deleting a Favorite Screen

- 1 Press **MENU**.
- 2 Tap **Universal** tab > Remove favorite.
- 3 Select the screen to delete, and tap **OK**.
- 4 Tap the **Close** icon.  
The screen closes.

Operation complete

# Setting the Measurement Mode

## Setting the Measurement Mode

The measurement mode determines how the entire GX/GP system operates. The GX/GP measurement characteristics change depending on the measurement mode. The measurement mode must be set before reconfiguration and before specifying various settings. By factory default, the measurement mode is set to Normal. When performing high-speed or dual interval measurement according to measurement conditions, you need to set the measurement mode to High speed or Dual interval.

- 1 Press **MENU**.
- 2 Tap the **Browse** tab.
- 3 Tap **Initialize Calibration**.
- 4 Tap **Measuremet mode**.
- 5 Setting the Measurement Mode.
- 6 Tap **Execute**.  
A confirmation screen is displayed.
- 7 Tap **OK**

**Operation complete**

### Note

- When the measurement mode is changed, the system restarts, and the following data is initialized. Set the measurement mode before reconfiguration and before specifying various settings.

Data subject to initialization
All internal data
All setting parameters including security settings but excluding communication settings
System configuration data

- You cannot set the measurement mode when recording, computation, or control execution is in progress.
- The measurement mode is not initialized during initialization.
- If the advanced security function (/AS) or multi-batch function (/BT) is enabled (On), the measurement mode is fixed to Normal.  
When changing the measurement mode, disable the functions beforehand.

## Limitations

Depending on the measurement mode, there is a limit to the number of measurement channels, the number of recording channels, and the supported modules. For the specific limitations, see the limitations provided in the following general specifications.

- GX/10/GX20 Paperless Recorder (panel mount type)  
General Specifications GS 04L51B01-01EN
- GP10/GP20 Paperless Recorder (portable type)  
General Specifications GS 04L52B01-01EN

This section explains what you need to do when you change the module configuration (by installing or removing modules).

# Reconfiguring the GX/GP (Module identification)

## Reconfiguring the GX/GP

When you reconfigure the GX/GP and the GX60, the installed I/O modules are detected, and the settings are changed accordingly.

Reconfiguration is necessary in the following situations.

- If you specify modules separately
- If you change the modules (change to different modules)
- If you add or remove modules
- If you connect the GX60
- When the measurement mode is changed
- When the advanced security function on/off state is changed

If you purchased a model with preinstalled modules (/U[] []0 or /CR[] option), you can start using the GX/GP right away without any reconfiguration. However, if you connect the GX60, change modules, add modules, or delete modules, you will need to reconfigure.

**Note**   
 You cannot reconfigure GX/GP while recording start ,math start, controlled.

- 1 Press **MENU**.
- 2 Tap the **Browse** tab.
- 3 Tap **Initialize Calibration**.
- 4 Tap **Reconfiguration**.
- 5 Tap **Execute**.  
The system information appears.

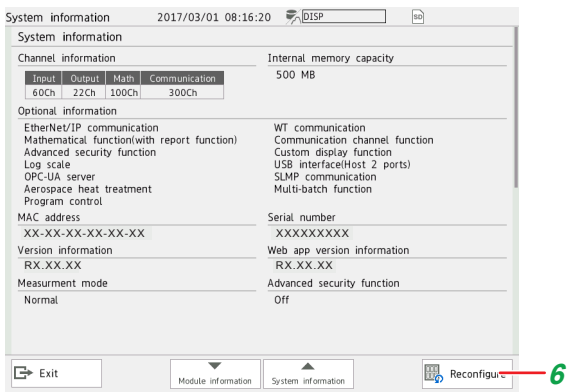

- 6 Tap **Reconfigure**.
- 7 Tap **OK**.

**Operation complete**

**Note**   
 Do not carry out the following operations while the GX/GP is reconfiguring.

- Turn the power off and on
- Insert or remove modules

This procedure is not necessary if you purchased an I/O module preinstalled model and do not need to change the configuration.

## Initializing the GX/GP (Initializing all settings)

Initialize the GX/GP after reconfiguring the GX/GP when channels are not assigned to display groups. Channels are automatically assigned during initialization. For details, see the User's Manual (IM 04L51B01-01EN).

**Note**   
 This procedure is not necessary if you purchased an I/O module preinstalled model and do not need to change the configuration.  
 If you initialize, setting parameters are reset to their factory defaults. We recommend that you back up setting parameters before initialization.

- 1 Press **MENU**.
- 2 Tap the **Browse** tab.
- 3 Tap **Initialize Calibration > Initialize > Settings/Inter data**.
- 4 Tap **Initialize all > On**.

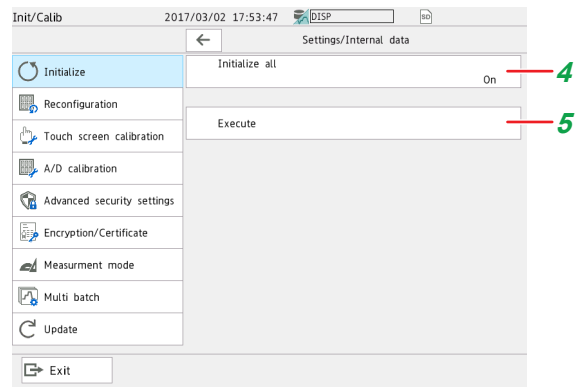

- 5 Tap **Execute**.  
A confirmation screen is displayed.
- 6 Tap **OK**.  
The settings are initialized.

**Operation complete**

This section explains how to back up setting parameters.

Before you change the module configuration or settings, we recommend that you back up the setting parameters.

## Saving and Loading Setting Parameters

### Saving Setting Parameters

Save setting parameters to the SD memory card with the file name "SF1."

**Path** MENU key > Browse tab > Save load  
> Menu Save settings > Setting parameters

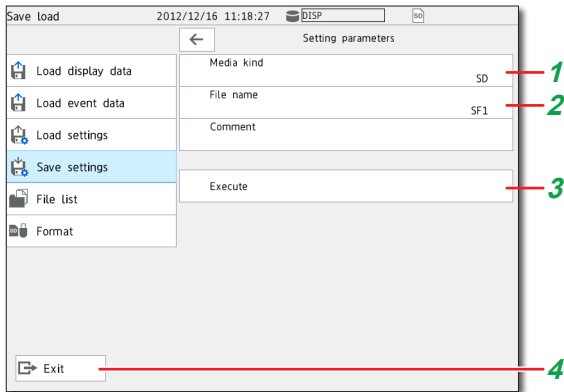

- 1 Tap **Media kind** > SD.
- 2 Tap **File name**, and enter SF1.
- 3 Tap **Execute**.
- 4 Tap **Exit**.

Operation complete

### Loading Setup Parameters

Load the setup parameter file "SF1.GNL" from the SD memory card.

**Path** MENU key > Browse tab > Save load  
> Menu Load settings > Setting parameters

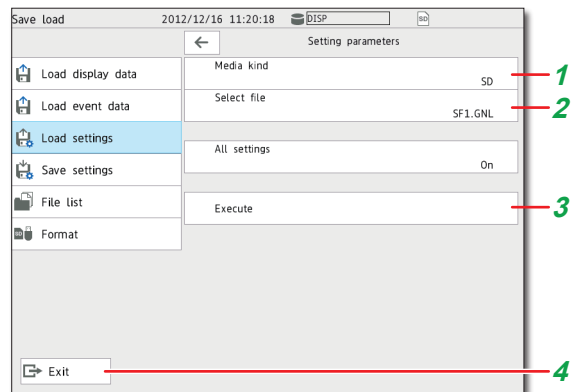

- 1 Tap **Media kind** > SD.
- 2 Tap **File name** > SF1.GNL.
- 3 Tap **Execute**.
- 4 Tap **Exit**.

Operation complete

# Web Application

You can open the Web application simply by starting a Web browser (IE11, Chrome 7x), and specifying the GX/GP IP address. You do not have to install any software. You can do the following on the Web application.

- Operate the GX/GP
- Monitor data
- Changing setting parameters

For details on configuring the environment settings to connect the GX/GP to an Ethernet network and how to use the software, see the User's Manual (IM 04L51B01-01EN).

## Starting the Web Application

- 1 Start the Web browser.
- 2 In the Address box, enter "http://" followed by the GX/GP IP address. If DNS is available, you can specify the host name in place of the IP address. Example: When the IP address is "192.168.1.1," enter http://192.168.1.1 in the Address box. The Web application starts, and the screen appears.

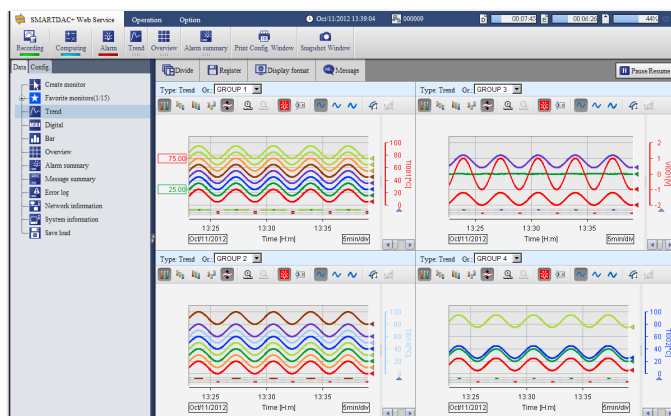

Operation complete

## Closing the Web Application

When close the Web browser, the Web application also closes.

# Application Software

The following software applications are available for the GX/GP.

- SMARTDAC+ STANDARD Universal Viewer
- SMARTDAC+ STANDARD Hardware Configurator (Included program pattern setting)

You can use SMARTDAC+ STANDARD Universal Viewer to display on screen and print the following types of data that is generated by recorders.

- Display data files
- Event data files
- Report data files (including hourly, daily, monthly, batch, and daily-custom, and free reports)
- Manual sampled data files

Two different recording data files can be displayed superimposed.

You can attach also convert measured data to ASCII or Excel formats.

You can use SMARTDAC+ STANDARD Hardware Configurator to create and edit setup data for the GX/GP recorder.

In addition, program patterns can be created and sent to the GX/GP.

You can download the latest software and labels from the following URL.

**URL:** [www.smartdacplus.com/software/en/](http://www.smartdacplus.com/software/en/)

You can the labels on the front door of the GX/GP.

Enter or print tag names on them for use. You can use

Microsoft Office Excel 2003 or later to edit the labels.

You can download the product user's manuals from the following URL.

**URL:** [www.smartdacplus.com/manual/en/](http://www.smartdacplus.com/manual/en/)

## PC System Requirements

### OS

OS	Type
Windows 7	Home Premium SP1 (32- or 64-bit edition)
	Professional SP1 (32- or 64-bit edition)
Windows 8.1	Update
	Pro Update
Windows 10	Home (32- or 64-bit edition)
	Pro (32- or 64-bit edition)

### CPU and main memory

OS	CPU and main memory
Windows 7	32-bit edition: Intel Pentium 4, 3 GHz or faster x64 or x86 processor. At least 2 GB of memory.
Windows 8.1	
Windows 10	64-bit edition: Intel Pentium 4, 3 GHz or faster x64 processor. At least 2 GB of memory.

### Web Browser

Compatible Browser	Version
Windows Internet Explorer	11
Google Chrome	7x

### Hard disk

Free space of at least 100 MB (depending on the amount of data, you may need more memory).

### Display

A video card that is recommended for the OS and a display that is supported by the OS, has a resolution of 1024×768 or higher, and that can show 65,536 colors (16-bit, high color) or more.

### Other Operating Conditions

To view the user's manuals, you need to use Adobe Reader 7 or later by Adobe Systems (the latest version recommended).

## Installation

To install Universal Viewer or Hardware Configurator, download the installer from the Yokogawa website.

**1** Turn on the PC, and start Windows.  
Log onto Windows as an administrator.

**2** Double click the installer (\*.exe).  
The installer starts. Follow the instructions on the screen to install the software.

### Note

- Close all other software applications before installing this software.
- To reinstall the software, uninstall the current software first.

### Hardware Configurator

- The "Countries/regions except Japan" selection dialog box appears during installation. Select the country that you will use the software in.
- The HTTP port for using the Web browser is set to 34443. If this port is already in use by another application, you will not be able to start Hardware Configurator even if you install it. In such a case, perform the corrective action on section 1.4 in SMARTDAC+ STANDARD Hardware Configurator User's Manual (IM 04L61B01-02EN).

## Application Software

### About the User's Manuals

The user's manual is installed with the software. To view the manual, on the **Help** menu, click **Instruction Manual**. You can also access it from **Start > All Programs**. Use Adobe Reader 7.0 or later to view the manual. The software and manual are installed for the following languages.

#### Universal Viewer

Language	Software	User's manual
Japanese	Japanese	Japanese
English	English	English
Chinese	Chinese	Chinese
French	French	English
German	German	
Russian	Russian	
Korean	Korean	

#### Hardware Configurator

Country Selected at Installation	Software	User's manual
Japanese	Display language selectable:	Japanese, English, Chinese
Regions except Japan	Japanese/English/ German/French/ Russian/Chinese/ Korean	

## Starting and Closing Universal Viewer

### Starting Universal Viewer

- From the Start menu, click **All Programs - SMARTDAC+ STANDARD - Viewer**. Universal Viewer starts.

### Closing Universal Viewer

- On the **File** menu, click **Exit**. Or, click the **x** button.

### Specifying a File Name and Opening the Data File

- On the **File** menu, click **Open**. Or, click **Open** on the toolbar. The Open dialog box appears.
- Select the data file you want to open, and click **Open**. Or, double-click the file. The data appears in the window.

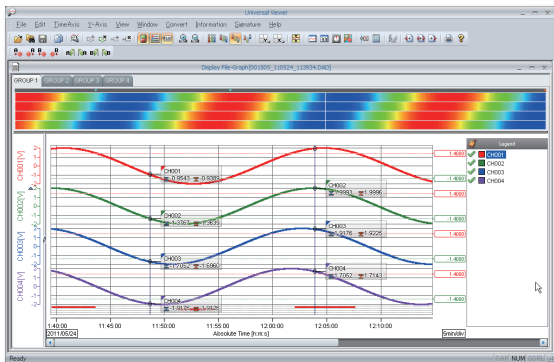

## Starting and Closing Hardware Configurator

### Starting Hardware Configurator

- From the **Start** menu, select **All Programs - SMARTDAC+ STANDARD - Hardware Configurator**.

The first time Hardware Configurator starts after installation, the Windows Security Alert dialog box appears. Click **Unblock**.

Hardware Configurator starts, and the following window appears.

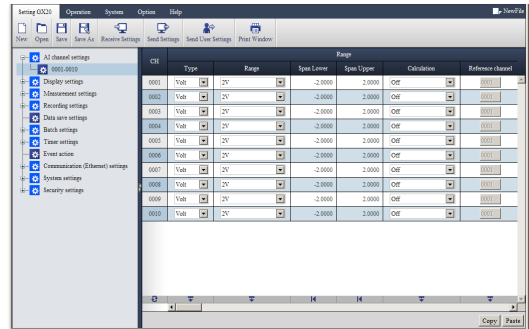

### Note

- Hardware Configurator will not start if Internet Explorer is not installed.
- The default settings are the system configuration of the GX10.

### Closing Hardware Configurator

Close Internet Explorer.

- Click the **Close** button; or on the **File** menu, click **Exit**.

### Note

If you change the setup data, the changes are stored and will appear the next time you start the software.



# Setup Menu Map

Depending on setting parameter values, some items may be hidden. For details, see the User's Manual (IM 04L51B01-01EN).

## AI channel settings, AI (mA) channel settings

### Range

First-CH
Last-CH
<b>Range</b>
Type
Range
Span Lower
Span Upper
Calculation
Reference channel
Scale
Decimal place
Scale Lower
Scale Upper
Unit
Low-cut
On/Off
Low-cut value
Low-cut output
Moving average
On/Off
Count
First-order lag filter <sup>2 3</sup>
On/Off
Filter coefficient
RJC <sup>1 3</sup>
Mode
Temperature
Burnout set <sup>3</sup>
Mode
Bias
Value

### Alarm

First-CH
Last-CH
Level 1
On/Off
Type
Value
Hysteresis
Logging
Output type
Output No.
Level 2
On/Off
Level 3
On/Off
Level 4
On/Off
Alarm delay
Hour
Minute
Second

## Display settings

First-CH
Last-CH
Tag
Characters
No.
Color
Color
Zone
Lower
Upper
Scale
Position
Division
Bar graph
Base position
Division
Partial
On/Off
Expand
Boundary
Color scale band
Band area
Color
Display position Lower
Display position Upper
Alarm point mark
Indicate on Scale
Mark kind
Alarm 1 color
Alarm 2 color
Alarm 3 color
Alarm 4 color
Display characters of each value
0
1

## Calibration correction

First-CH
Last-CH
Mode
Mode
Number of set points
1
Linearizer input
Linearizer output
Execution of input measurement
:
12
Linearizer input
Linearizer output
Execution of input measurement

## Setup Menu Map

Setting when the mode is set to Correction Coefficient on a module with an /AH option

1	Uncorrected value
	Instrument correction factor
	Sensor correction factor
	Execution of input measurement
:	
12	Uncorrected value
	Instrument correction factor
	Sensor correction factor
	Execution of input measurement

- 1 Not displayed for AI (mA) channel setting.
- 2 Appears for channels of high-speed AI modules
- 3 Not displayed for 4-wire RTD/resistance type.

DI channel settings																											
Range	<table border="1"> <tr><td>First-CH</td></tr> <tr><td>Last-CH</td></tr> <tr><td>Range</td></tr> <tr><td>Type</td></tr> <tr><td>Span Lower</td></tr> <tr><td>Span Upper</td></tr> <tr><td>Calculation</td></tr> <tr><td>Reference channel</td></tr> <tr><td>Scale</td></tr> <tr><td>Decimal place</td></tr> <tr><td>Scale Lower</td></tr> <tr><td>Scale Upper</td></tr> <tr><td>Unit</td></tr> </table>	First-CH	Last-CH	Range	Type	Span Lower	Span Upper	Calculation	Reference channel	Scale	Decimal place	Scale Lower	Scale Upper	Unit													
First-CH																											
Last-CH																											
Range																											
Type																											
Span Lower																											
Span Upper																											
Calculation																											
Reference channel																											
Scale																											
Decimal place																											
Scale Lower																											
Scale Upper																											
Unit																											
Alarm	<table border="1"> <tr><td>First-CH</td></tr> <tr><td>Last-CH</td></tr> <tr><td>Level 1</td></tr> <tr><td>On/Off</td></tr> <tr><td>Type</td></tr> <tr><td>Value</td></tr> <tr><td>Hysteresis</td></tr> <tr><td>Logging</td></tr> <tr><td>Output type</td></tr> <tr><td>Output No.</td></tr> <tr><td>Level 2</td></tr> <tr><td>On/Off</td></tr> <tr><td>Level 3</td></tr> <tr><td>On/Off</td></tr> <tr><td>Level 4</td></tr> <tr><td>On/Off</td></tr> <tr><td>Alarm delay</td></tr> <tr><td>Hour</td></tr> <tr><td>Minute</td></tr> <tr><td>Second</td></tr> </table>	First-CH	Last-CH	Level 1	On/Off	Type	Value	Hysteresis	Logging	Output type	Output No.	Level 2	On/Off	Level 3	On/Off	Level 4	On/Off	Alarm delay	Hour	Minute	Second						
First-CH																											
Last-CH																											
Level 1																											
On/Off																											
Type																											
Value																											
Hysteresis																											
Logging																											
Output type																											
Output No.																											
Level 2																											
On/Off																											
Level 3																											
On/Off																											
Level 4																											
On/Off																											
Alarm delay																											
Hour																											
Minute																											
Second																											
Display settings	<table border="1"> <tr><td>First-CH</td></tr> <tr><td>Last-CH</td></tr> <tr><td>Tag</td></tr> <tr><td>Characters</td></tr> <tr><td>No.</td></tr> <tr><td>Color</td></tr> <tr><td>Color</td></tr> <tr><td>Zone</td></tr> <tr><td>Lower</td></tr> <tr><td>Upper</td></tr> <tr><td>Scale</td></tr> <tr><td>Position</td></tr> <tr><td>Division*</td></tr> <tr><td>Bar graph</td></tr> <tr><td>Base position</td></tr> <tr><td>Division*</td></tr> <tr><td>Alarm point mark</td></tr> <tr><td>Indicate on Scale</td></tr> <tr><td>Mark kind</td></tr> <tr><td>Alarm 1 color</td></tr> <tr><td>Alarm 2 color</td></tr> <tr><td>Alarm 3 color</td></tr> <tr><td>Alarm 4 color</td></tr> <tr><td>Display characters of each value</td></tr> <tr><td>0</td></tr> <tr><td>1</td></tr> </table>	First-CH	Last-CH	Tag	Characters	No.	Color	Color	Zone	Lower	Upper	Scale	Position	Division*	Bar graph	Base position	Division*	Alarm point mark	Indicate on Scale	Mark kind	Alarm 1 color	Alarm 2 color	Alarm 3 color	Alarm 4 color	Display characters of each value	0	1
First-CH																											
Last-CH																											
Tag																											
Characters																											
No.																											
Color																											
Color																											
Zone																											
Lower																											
Upper																											
Scale																											
Position																											
Division*																											
Bar graph																											
Base position																											
Division*																											
Alarm point mark																											
Indicate on Scale																											
Mark kind																											
Alarm 1 color																											
Alarm 2 color																											
Alarm 3 color																											
Alarm 4 color																											
Display characters of each value																											
0																											
1																											

\* When the range type is set to Pulse.

Pulse input channel settings

Range	First-CH
	Last-CH
	Range
	Type
	Range
	Chattering filter
	Span Lower
	Span Upper
	Calculation
	Reference channel
	Scale
	Decimal place
	Scale Lower
	Scale Upper
	Unit
	Moving average
	On/Off
	Count

Alarm	First-CH
	Last-CH
	Level 1
	On/Off
	Type
	Value
	Hysteresis
	Logging
	Output type
	Output No.
	Level 2
	On/Off
	Level 3
	On/Off
	Level 4
	On/Off
	Alarm delay
	Hour
	Minute
	Second

Display settings	First-CH
	Last-CH
	Tag
	Characters
	No.
	Color
	Color
	Zone
	Lower
	Upper
	Scale
	Position
	Division
	Bar graph
	Base position
	Division
	Color scale band
	Band area
	Color
	Display position Lower
	Display position Upper
	Alarm point mark
	Indicate on Scale
	Mark kind
	Alarm 1 color
	Alarm 2 color
	Alarm 3 color
	Alarm 4 color

AO channel settings

Range	First-CH
	Last-CH
	Range
	Type
	Range
	Span Lower
	Span Upper
	Reference channel
	Channel type
	Channel no
	Preset value
	Preset value
	Preset action
	At power on
	On error
	During stop conditions

Display settings	First-CH
	Last-CH
	Tag
	Characters
	No.
	Color
	Color
	Zone
	Lower
	Upper
	Scale
	Position
	Division
	Bar graph
	Base position
	Division

DO channel settings

Range	First-CH
	Last-CH
	Range
	Type
	Span Lower
	Span Upper
	Unit
	Action
	Energize/De-energize
	Action
	Hold
	Relay Action on ACK
	Relay deactivated interval

Display settings	First-CH
	Last-CH
	Tag
	Characters
	No.
	Color
	Color
	Zone
	Lower
	Upper
	Scale
	Position
	Bar graph
	Base position
	Display characters of each value
	0
	1

# Setup Menu Map

## Math channel settings

Calculation expression
First-CH
Last-CH
Math range
On/Off
Calculation expression
Decimal place
Span Lower
Span Upper
Unit
TLOG
Timer type
Timer No.
Sum scale
Reset
Rolling average
On/Off
Interval
Number of samples

Alarm
First-CH
Last-CH
Level 1
On/Off
Type
Value
Hysteresis
Logging
Output type
Output No.
Level 2
On/Off
Level 3
On/Off
Level 4
On/Off
Alarm delay
Hour
Minute
Second

Display settings
First-CH
Last-CH
Tag
Characters
No.
Color
Color
Zone
Lower
Upper
Scale
Position
Division
Bar graph
Base position
Division
Partial
On/Off
Expand
Boundary
Color scale band
Band area
Color
Display position Lower
Display position Upper
Alarm point mark
Indicate on Scale
Mark kind
Alarm 1 color
Alarm 2 color
Alarm 3 color
Alarm 4 color

Constant
Number of constant
Constant
K001
:
K100

Variable constant
Constant number
Constant
W001
:
W100

Math action settings
Value on Error
START/STOP key action
Value on Overflow
SUM, AVE
MAX, MIN, P-P
Operation when PSUM arithmetic overflows
OVER/ROTATE

## Logic math settings

Logic math number
Output
Output type
Output No.
Calculation expression
Calculation expression

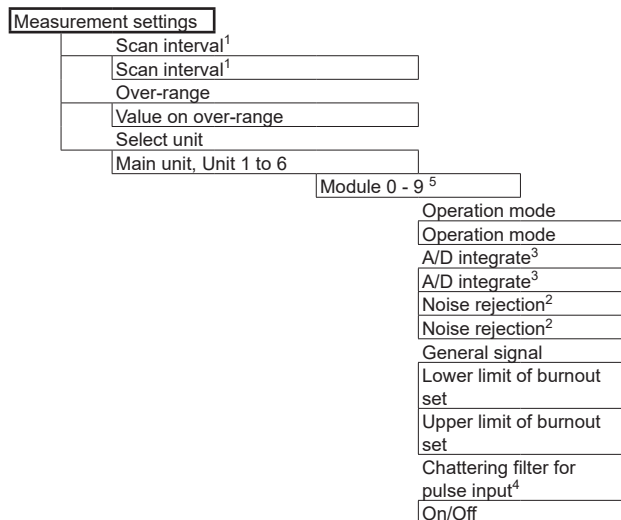
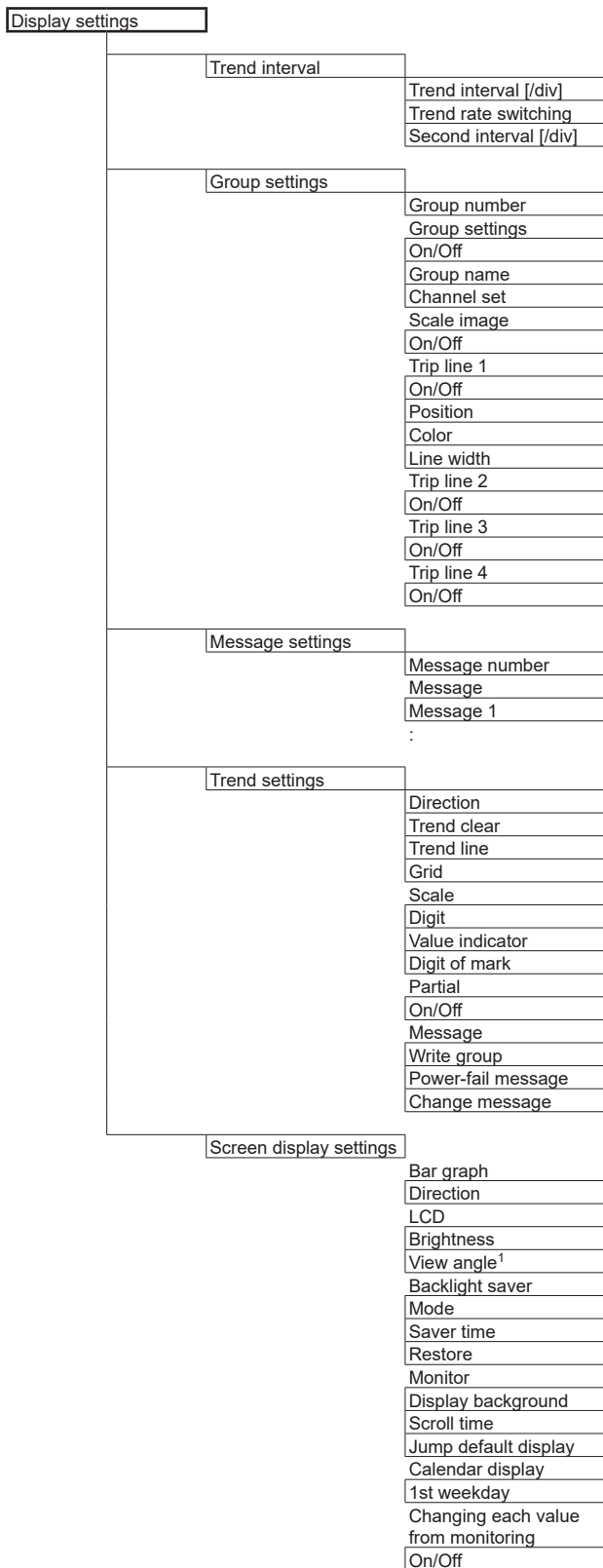

- 1 Does not appear when the measurement mode is Duall interval.
- 2 Appears when the GX90XA type is -H0 and with PID control modules.
- 3 Does not appear with high-speed AI or PID control modules.
- 4 Pulse input module only
- 5 Does not appear with AO or DO modules.

When the measurement mode is set to dual interval

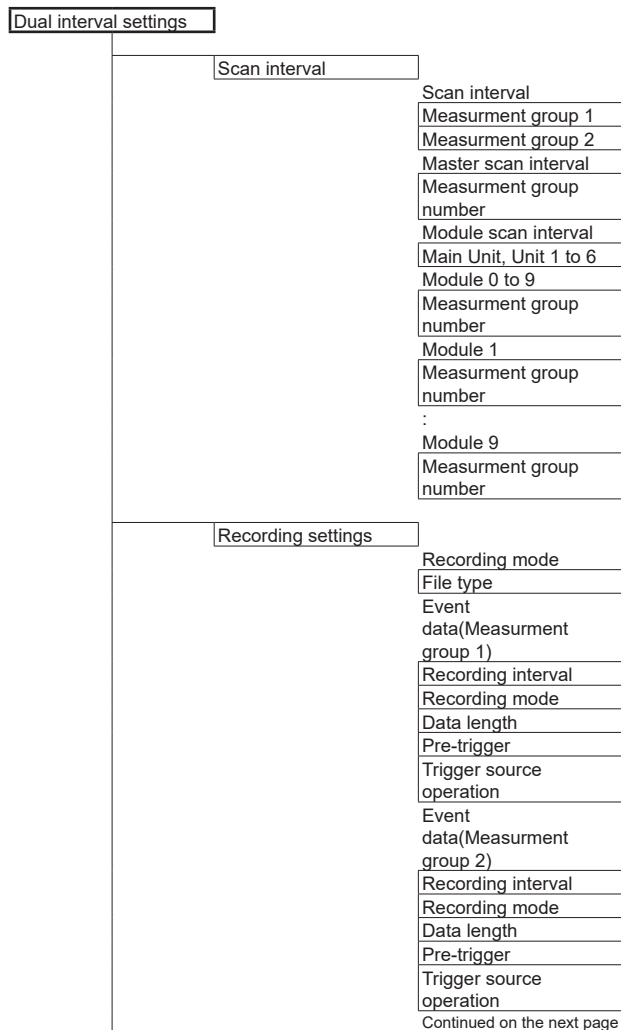

- 1 GX10/GP10 only.
- 2 Does not appear when the measurement mode is High speed.
- 3 Does not appear when the measurement mode is Duall interval.

Continued on the next page

# Setup Menu Map

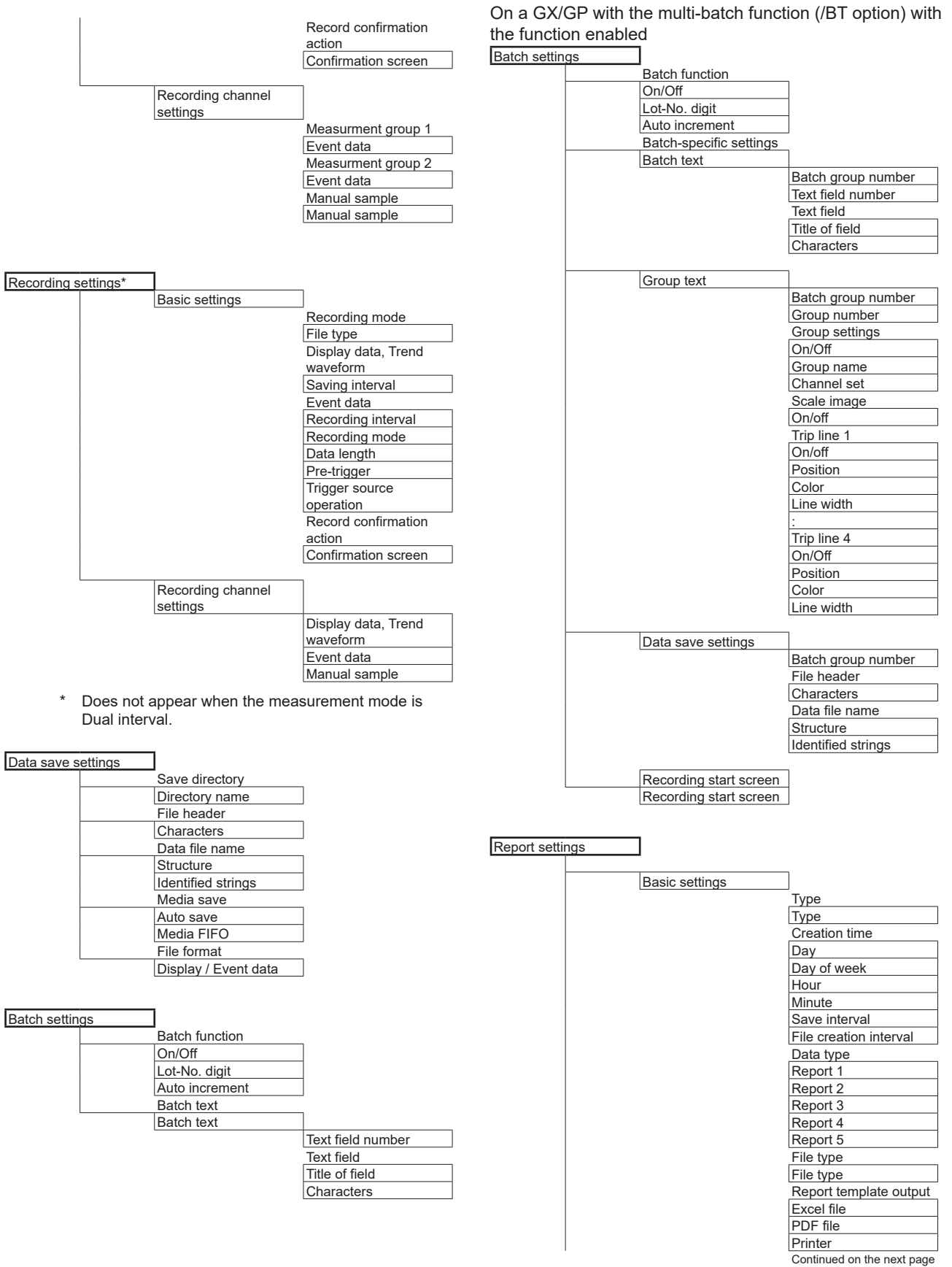

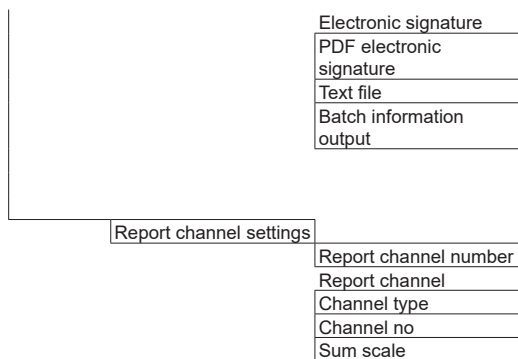

When a PID control module is installed

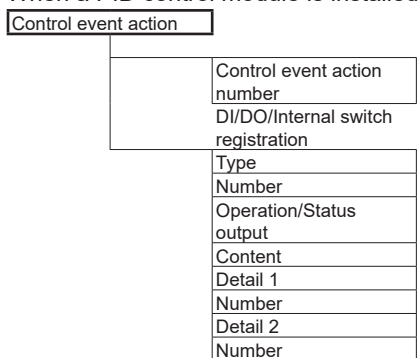

Timer settings

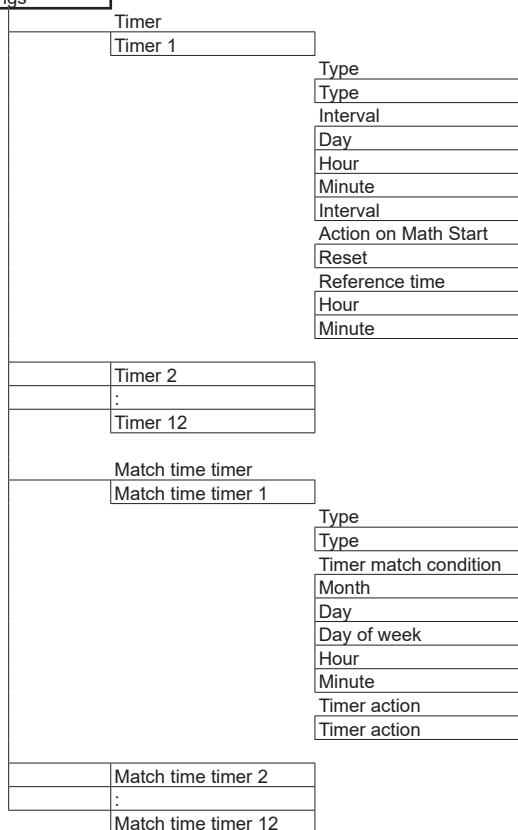

Only on GX/GPs with the /AH Aerospace heat treatment

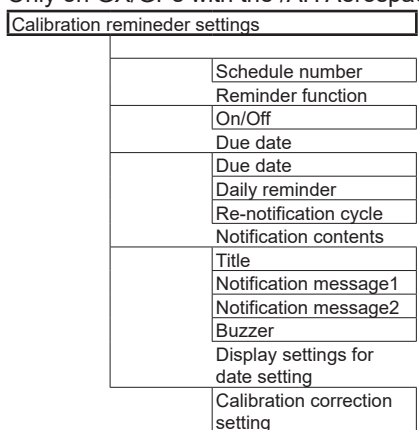

Communication channel settings

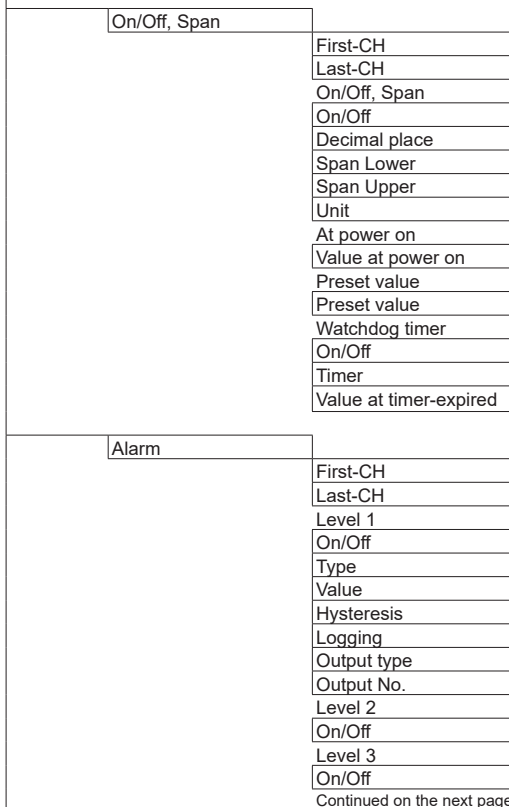

Event action

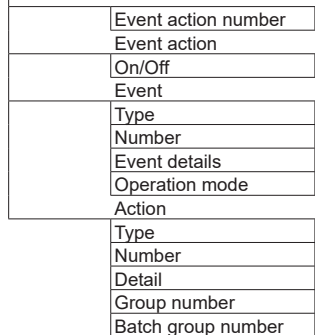

Continued on the next page

## Setup Menu Map

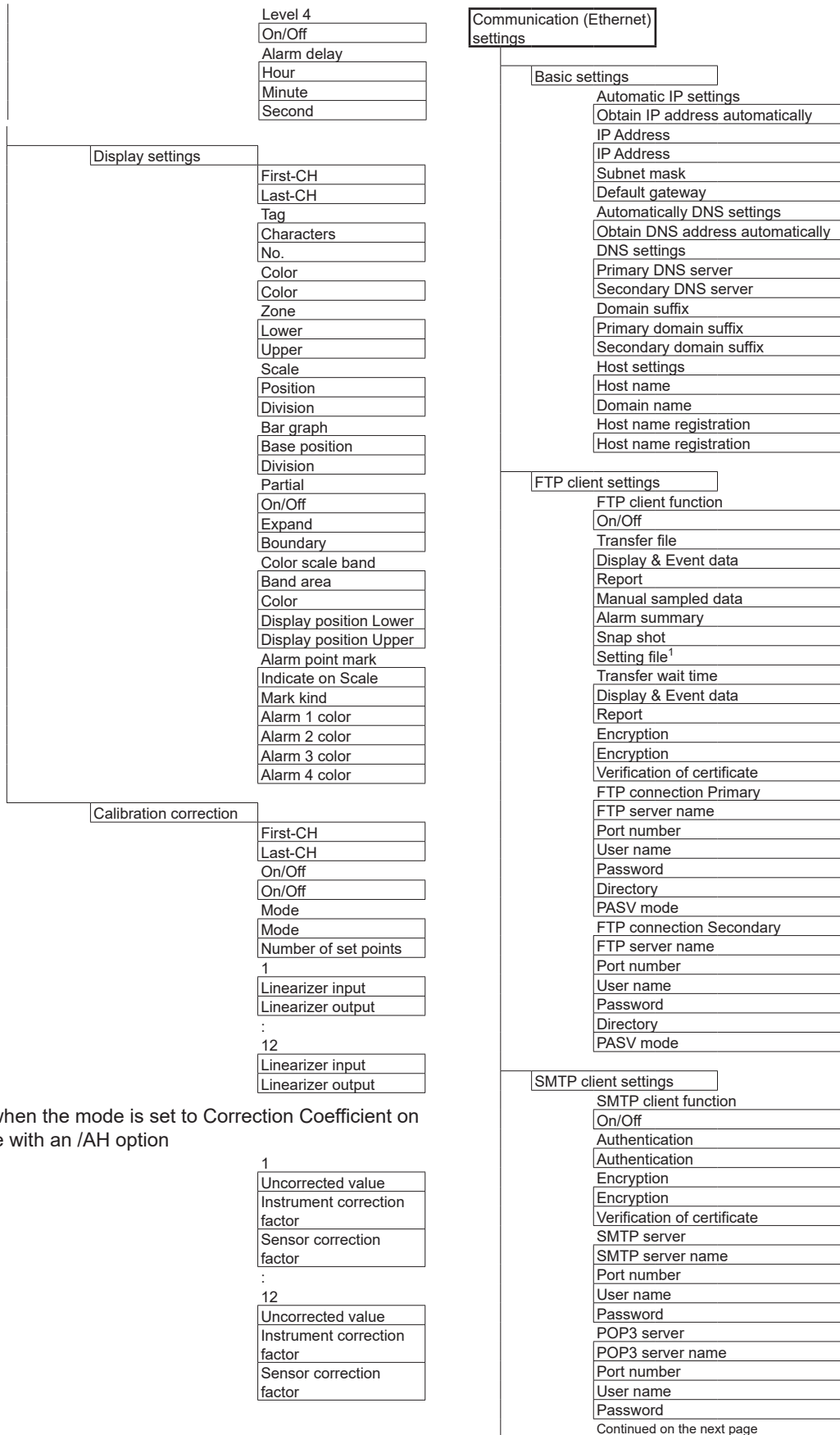



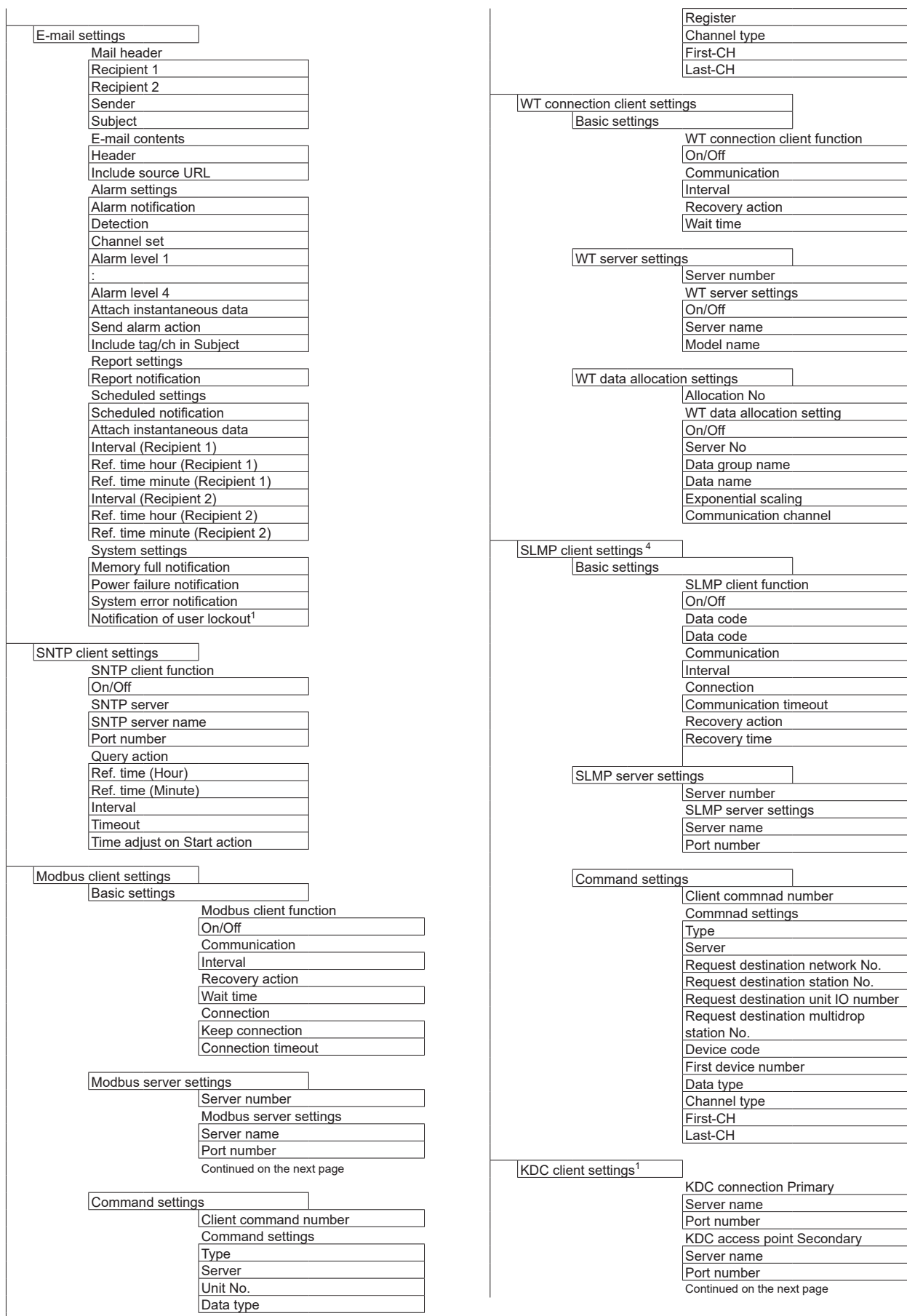

# Setup Menu Map

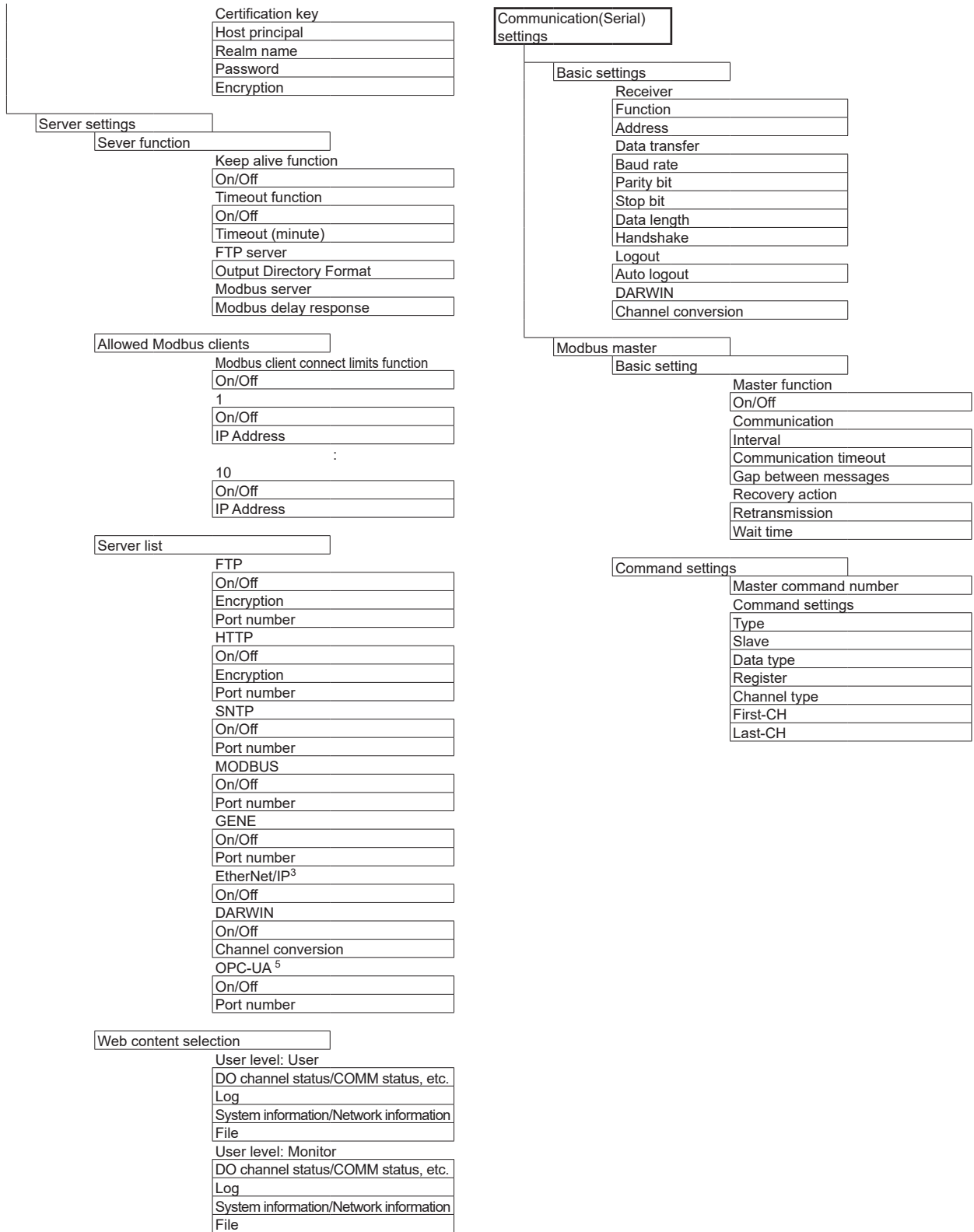

- 1 On a GX/GP with the advanced security function (/AS option) with the function enabled
- 2 Only on GX/GPs with the /E2 WT communication option.
- 3 Only on GX/GPs with the /E1 EtherNet/IP communication option.
- 4 Only on GX/GPs with the /E4 SLMP communication
- 5 Only on GX/GPs with the /E3 OPC-UA server.

System settings

Environment (Language) settings	Language
	Temperature
	Decimal Point Type
	Date format
	Date format
	Delimiter
	Month indicator
Alarm basic settings	Rate of change
	Decrease
	Increase
	Indicator
	Hold/Nonhold
	Alarm ACK
	Individual alarm ACK
Time basic settings	Time zone
	Hour
	Minute
	Gradually adjusting the time
	Time deviation limit
	Time adjustment beyond limit
	Daylight Saving Time
	Use/Not
	Start time
	Month
	Day order
	Day of the week
	Hour of the day
	End time
	Month
	Day order
	Day of the week
	Hour of the day
Internal switch settings	First number
	Last number
	Internal switch
	Type
	And/Or
	Preset action
	At power on
Status relay	Fail relay
	Memory/Media status
	Measurement error
	Communication error
	Record stop
	Alarm
Printer settings	IP Address
	Paper size
	Page orientation
	Resolution (dpi)
	Number of copies
	Snapshot
	Paper size indicator
Sound, LED	Sound
	Touch
	Warning
	LED
	MENU key LED

Instruments tag	Instruments tag
	Instrument tag No.
Setting file	Setting file comment
	Configuration change comment <sup>1</sup>
	Input comment
USB input device	USB input device

1 On a GX/GP with the advanced security function (/AS option) with the function enabled.

Security settings

Basic settings	Security function
	Touch operation
	Communication
	Logout
	Auto logout
	Operation without Login
	Password management <sup>1</sup>
	On/Off
	Root user password
	Password retry <sup>1</sup>
	Password retry
	User ID <sup>1</sup>
	On/Off
User settings	User number
	User settings
	User level
	Mode
	User name
	User ID <sup>1</sup>
	Initialize password
	Password expiration <sup>1</sup>
	User property
	Authority number
	Sign in property <sup>1</sup>
	Authority of signature <sup>1</sup>
Authority of user	Authority number
	Authority of user
	Record
	Math
	Data save
	Message
	Batch
	Alarm ACK
	Communication
	Touch operation
	Time set
	Setting operation
	Calibration correction <sup>1</sup>
	External media
	System operation
	Output operation
	Remote/Local operation <sup>2</sup>
	Control operation <sup>2</sup>
	Tuning operation <sup>2</sup>
	SP operation <sup>2</sup>
	Program operation <sup>2</sup>
	Continued on the next page

# Setup Menu Map

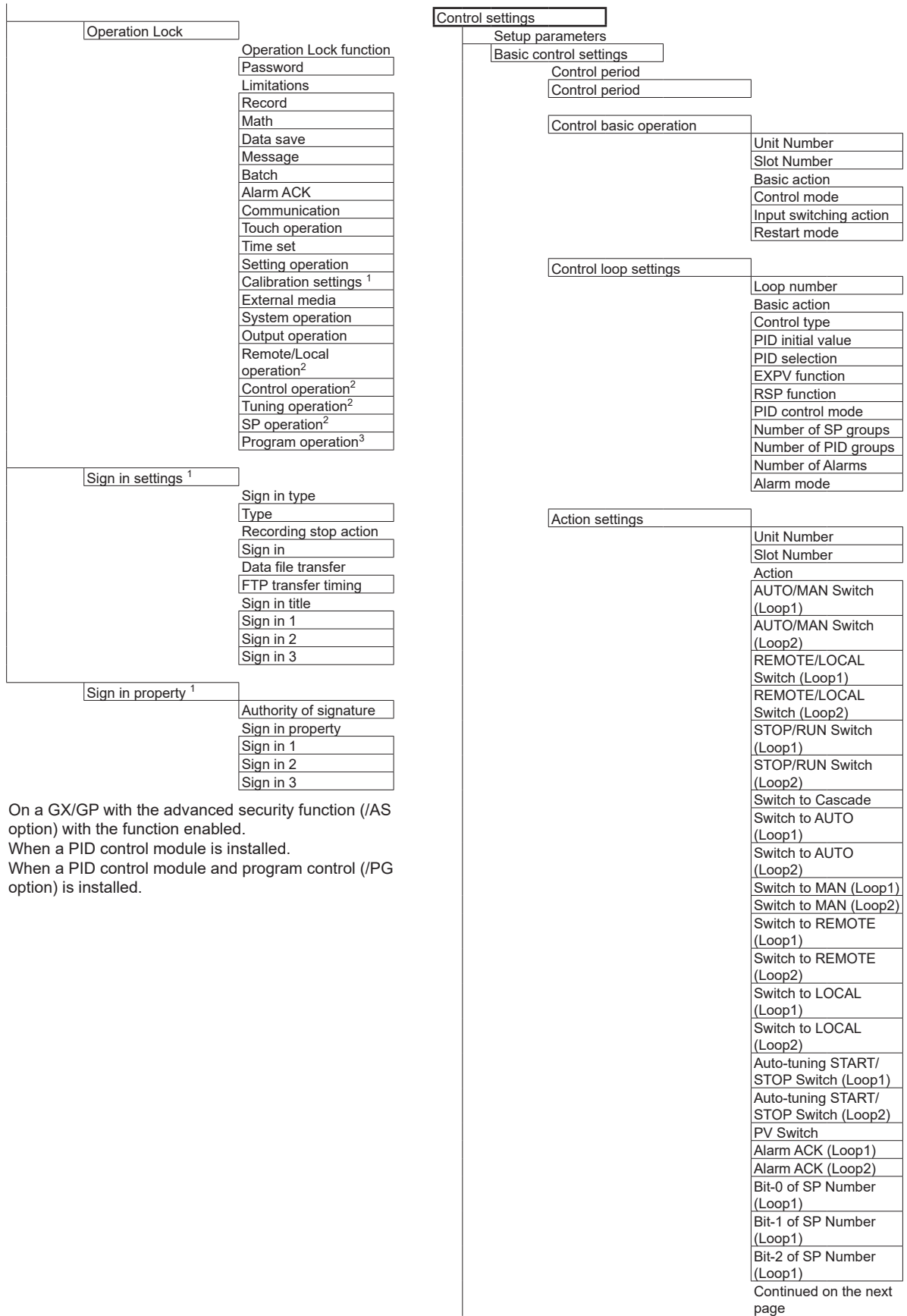

- 1 On a GX/GP with the advanced security function (/AS option) with the function enabled.
- 2 When a PID control module is installed.
- 3 When a PID control module and program control (/PG option) is installed.

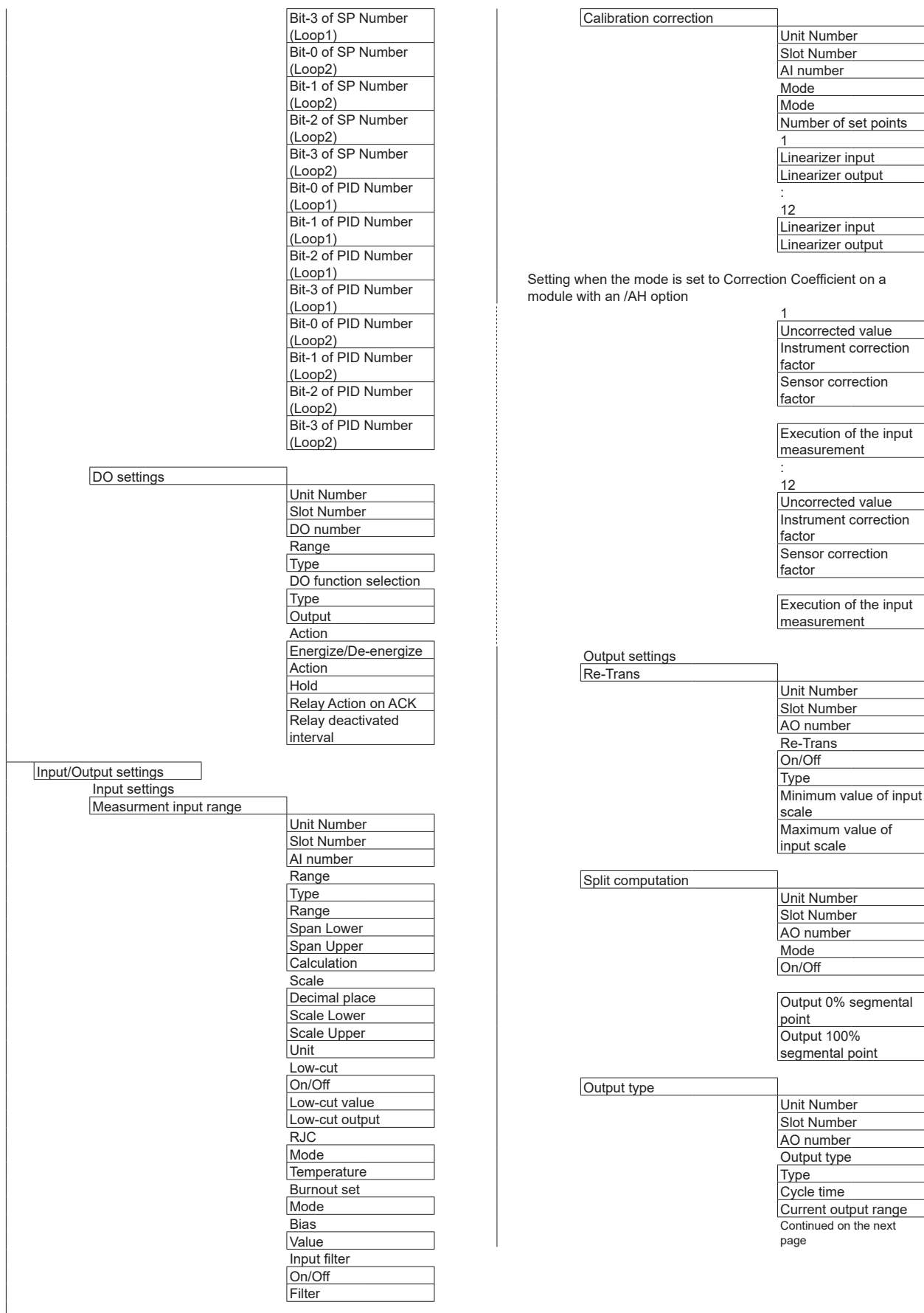



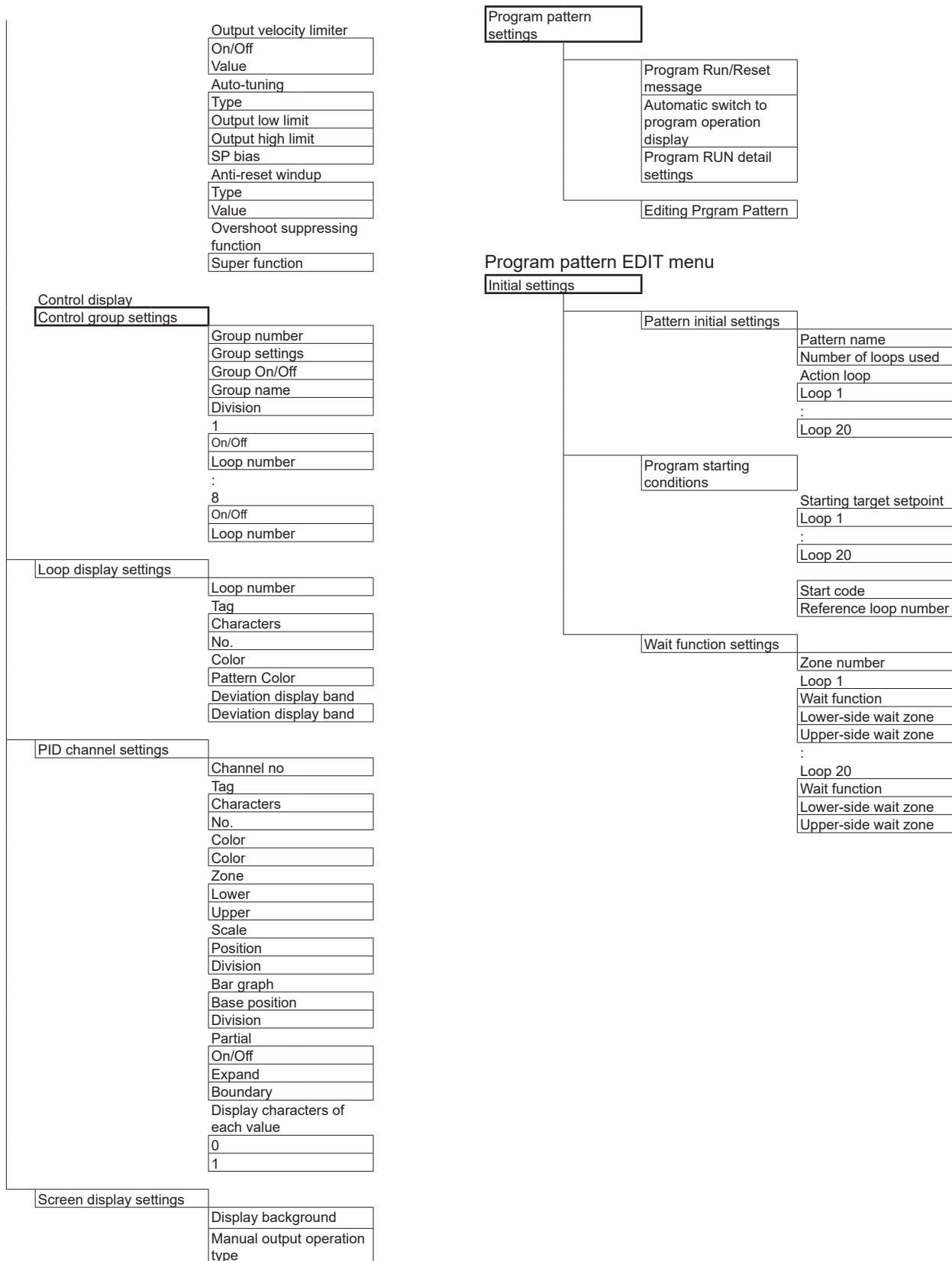

## Setup Menu Map

