

**OpreX™** Yokogawa achieves operational excellence by providing products, services, and solutions based on the OpreX comprehensive brand that cover everything from business management to operations.

**Yokogawa Electric Corporation  
World Headquarters**

9-32, Nakacho 2-chome, Musashino-shi, Tokyo 180-8750, Japan  
<http://www.yokogawa.com/>

**Yokogawa Corporation of America**

12530 West Airport Blvd, Sugar Land, Texas 77478, USA  
<http://www.yokogawa.com/us/>

**Yokogawa América do Sul Ltda.**

Alameda Xingu, 850 - Alphaville Industrial,  
Barueri - São Paulo/SP, 06455-030, Brazil  
<http://www.yokogawa.com.br>

**Yokogawa Europe B. V.**

Euroweg 2, 3825 HD Amersfoort, The Netherlands  
<http://www.yokogawa.com/eu/>

**Yokogawa Electric CIS Ltd.**

1, Samarskaya street, business center Novion, Moscow, 129110, Russia  
<http://www.yokogawa.ru>

**Yokogawa Middle East & Africa B. S. C. (c)**

Building 577, Road 2516, Busaiteen 225, Muharraq, Bahrain  
<http://www.yokogawa.com/bh/>

**Yokogawa India Ltd.**

Plot No.96, Electronic City Complex, Hosur Road, Bangalore - 560 100, India  
<https://www.yokogawa.com/in/>

Visit our website (Read or Click) :



**Yokogawa China Co., Ltd.**

Room 1801, Tower B, Hongqiao Nanfeng City,  
No.100 Zunyi Road, Changning District,  
Shanghai, 200051, China  
<http://www.yokogawa.com/cn/>

**Yokogawa Engineering Asia Pte. Ltd.**

5 Bedok South Road, Singapore 469270, Singapore  
<http://www.yokogawa.com/sg/>

**Yokogawa Electric Korea Co., Ltd.**

(Yokogawa B/D, Yangpyeong-dong 4-Ga), 21, Seonyu-ro 45-gil,  
Yeongdeungpo-gu, Seoul, 07209, Korea  
<http://www.yokogawa.com/kr/>

**Yokogawa Solution Service Corporation**

9-32, Nakacho 2-chome, Musashino-shi, Tokyo 180-8750, Japan  
<http://www.yokogawa.com/yjp/>

Printed in Japan, 209(KP) [Ed : 07/d]

Trademarks

All brand or product names of Yokogawa Electric Corporation in this bulletin are trademarks or registered trademarks of Yokogawa Electric Corporation. All other company brand or product names in this bulletin are trademarks or registered trademarks of their respective holders.

Subject to change without notice.

All Rights Reserved. Copyright © 2022, Yokogawa Electric Corporation



OpreX™ Field Instruments

# Magnetic Flowmeter Flow measurement

Designed by Total Insight concept

The Total Insight concept supports the entire product life cycle.

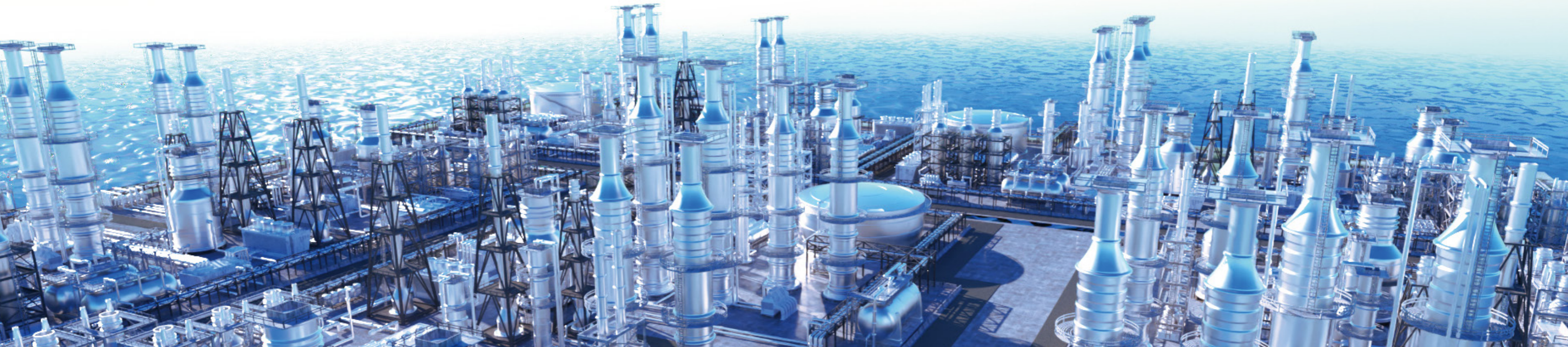

## History of Yokogawa magnetic flowmeter



**1955**  
**FL280**  
 AC excitation  
 First magnetic flowmeter of Yokogawa



**1983**  
**YEW MAG**  
 Signal processing pulsed DC



**1988**  
**ADMAG AM**  
 Dual frequency excitation, Alumina ceramics sensor tube



**1994**  
**ADMAG AE**  
 Integral explosion proof type



**1995**  
**ADMAG CA**  
 Capacitance electrode, 0.01 μS/cm low conductivity measurement



**2003**  
**ADMAG AXF**  
 Enhanced dual frequency excitation, Adhesion check function



**2009**  
**ADMAG AXR**  
 Two-wire with dual frequency excitation



**2012**  
**ADMAG AXW**  
 Large size sensor 500mm - 1800mm



**2019**  
**ADMAG TI AXG1A**  
 ADMAG TI Series high-grade remote transmitter

**2017**  
**ADMAG TI**  
 Two product lineups AXG/AXW with "Total Insight" concept

**2022**  
 New release of **Magnetic Flowmeter CA Series**

*Always be your first choice in flow measurement*

Yokogawa magnetic flowmeters are supported by a long history of more than half a century. We added innovative specifications in each era and have always been leading the industry. The consistent policy of Yokogawa magnetic flowmeter is to have high performance and high quality. The world's first dual frequency excitation method adopted in the ADMAG AM series announced in 1988 has set an unmatched standard of measurement stability of magnetic flowmeter. Capacitance type magnetic flowmeter ADMAG CA series has made it possible to measure insulating adhesive fluid, semisolid highly concentrated slurry and low conductivity fluid. ADMAG AXR series has realized overwhelming high performance with limited power supply voltage of two-wires. And now, the birth of the ADMAG TI, adopting the "Total Insight" concept which totally supports the life cycle of the product.



## Stable Measurement of Slurry and Insulator-adhering fluids

Fluids containing slurry or adhesive fluid of insulator are difficult to measure with ordinary flowmeters. Even with magnetic flowmeters that has no moving parts and no obstacles in the measurement tube, noise is generated in the detection signal through the electrode when a solid particle collides with the electrode part.



Are there difficult fluid measurements that can't be resolved, regardless of the flowmeter type? The CA Series can solve most of your challenging applications.

OpreX™ Field Instruments

# Magnetic Flowmeter CA Series

YOKOGAWA's field instruments now include a new magnetic flowmeter

[Click here for the product homepage and Promotion Video](#)



### Special construction with non-wetted electrodes

Magnetic Flowmeter CA Series are structured differently from ordinary magnetic flowmeters. The measuring tube, made of alumina ceramics, has no electrodes in contact with the measured fluid. Therefore, slurry does not come in contact with the electrode and adhesive fluid does not accumulate on the electrode, thus ensuring stable measurement.

Magnetic Flowmeter CA Series  
Non-wetted Capacitance Electrode

Non-wetted Capacitance Electrode

Ordinary Magnetic Flowmeters  
Wetted Electrode

Electrode

Output

Non-wetted Capacitance Electrode

Electrode

Slurry

Slurry

## Measurement of ultra-low conductivity fluids

Magnetic Flowmeter CA Series can measure ultra-low conductivity fluids. The excellent features of the magnetic flowmeter, such as no pressure drop and no moving parts and maintenance-free, are retained to enable measurement of ultra-low conductivity fluids of 0.01  $\mu\text{S}/\text{cm}$  or more.

### High Purity Alumina Ceramics Measuring Tubes

The measuring pipe of the Magnetic Flowmeter CA series is made of alumina ceramics. The Vickers hardness of alumina ceramics is about three times that of stainless steel. The wear resistance of alumina ceramics is also much higher than that of stainless steel, making it an extremely hard material. It is an extremely hard material. The ceramic measuring tube structure, which has few irregularities, is resistant to fluid adhesion. The ceramic measuring tube structure with few irregularities is resistant to fluid adhesion. The mirror-finish version is used for adhesive fluids can be used to further improve the smoothness of the inner surface.

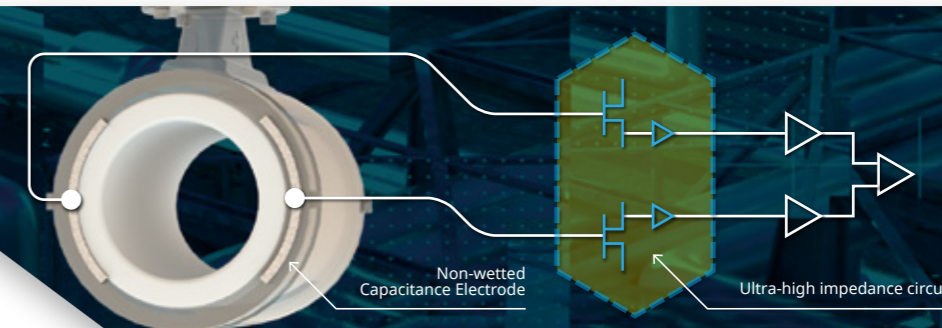
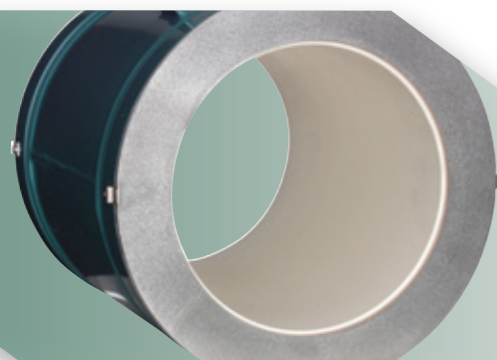

## Combination of anti noise and zero point stability by YOKOGAWA's unique Dual Frequency Excitation Method

Dual Frequency Excitation Method is YOKOGAWA's unique excitation method combining High Frequency Excitation and Low Frequency Excitation. It combines the advantages of low frequency excitation zero points stability, high frequency excitation noise resistance and high speed response.

Excitation Method	Zero point Stability	Anti-Noise	Fast Response
Dual Frequency Excitation	◎	◎	◎
High Frequency Excitation	×	○	○
Low Frequency Excitation	○	×	×

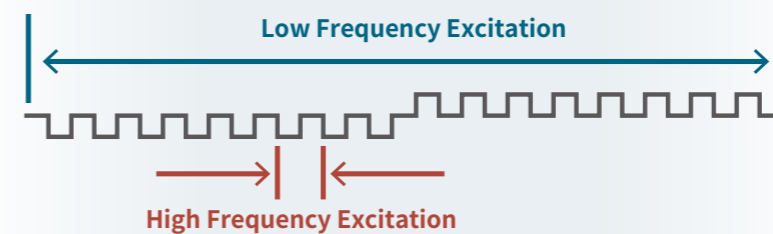

## High Accuracy

The ADMAG TI series electromagnetic flowmeter has a standard accuracy of 0.3% for AXG and 0.35% for AXW. Furthermore, YOKOGAWA has achieved this high accuracy over a wide range of flow rates.

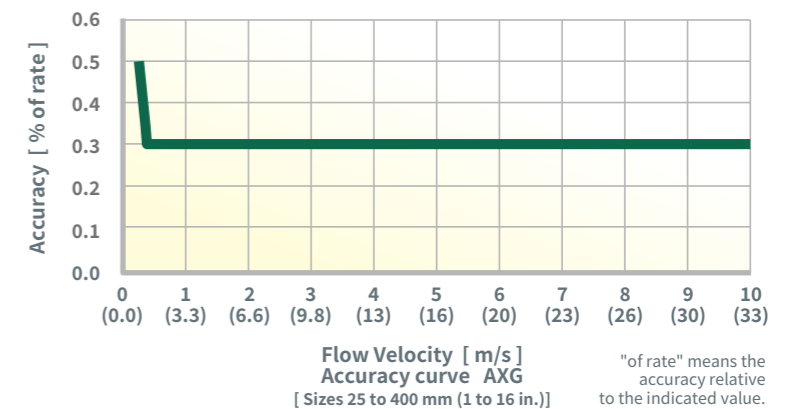

## High robustness

The inner surface of the measuring pipe of a magnetic flowmeter is formed of an insulating material, usually resin or rubber lining the inner surface of the metal measuring tube.

AXG's PFA lining is made by injection molding molten PFA at high temperature, intertwining it with a perforated metal plate lining fixing plate, and securing it to the measuring tube. This makes the structure particularly robust, and the lining will not deform even under conditions of severe negative pressure changes or permeable fluids.



# AXG/AXW Magnetic Flowmeter

[Click here for the product homepage](#)



**Expert Solution**   
Utility and Maintenance

 **Simplified Selection**  
Engineering and Procurement

# Total Insight

**Process Guard**   
Operation and Observation

 **Smart Assist**  
Installation and Commissioning



## What is required of a field device at the customer site based on high performance and high quality?

In case of field devices, customers require full support over the entire product life cycle such as easy selection of product specifications, instrument set up, operation, monitoring of process, simplified troubleshooting when product fails, flexibility for future upgrades and so on.

Yokogawa's flowmeter adopts the new "Total Insight" concept which provides total support to customers. For example, the AXG and AXW transmitters have a wizard function for easy parameter setting. Self-diagnostics check measurement result and automatically detect abnormalities. The built-in health check verification function can easily verify the device conditions in as little as 12 minutes for AXG/AXW and 6 minutes for CA and can output reports using the DTM tool. The flowmeters have in-built intelligence to detect process abnormalities such as flow noise (slurry, air bubbles) and changing fluid conductivity. These alarms can be logged for further analysis thereby maintaining the integrity of the process. These functions can be expected for detecting the timing of fluid changes, estimating liner abrasion etc.

These advanced new functionalities offered by the "Total Insight" concept enable more accurate and stable measurement of your process.

## Total Insight

# Simplified Selection



01

## Two dedicated product lines

**AXG**



- Purpose**
- Superior measurement accuracy for demanding process
    - Standard accuracy :  $\pm 0.3\%$  of rate
    - High accuracy :  $\pm 0.15\%$  of rate (25 to 200mm)
  - Stable and reliable measurement for severe application
- Demands**
- High accuracy, application diagnostics
  - High durability, wide selection of wetted parts material
  - Intrinsically safe Output (To be released)
  - Current input for process temperature (Calorie calculation, Density correction calculation for mass flow rate measurement)

**AXW**



- Purpose**
- Accurate measurement for versatile application at lower cost of ownership
    - Standard accuracy:  $\pm 0.35\%$  of rate
  - Reliable measurement in versatile applications
- Demands**
- Fast and reliable measurement with noise immunity

**CA**



- Purpose**
- Stable Measurement of Slurry and Insulator-Adhering Fluid
  - Measurement of ultra-low conductivity fluids
- Demands**
- Stable measurement of fluids that are difficult to measure stably even with AXG

## Product Finder

Selecting the suitable flowmeter should be simple and, with the Yokogawa selection tool, it is. The tool allows you to select the best size, materials, and functionality for your process to ensure the optimal unit to be selected for your application. From selecting the best unit to choosing the functionality required, it is all done in a matter of a few clicks.



## Cable connection check function

Reduce your installation and commissioning time by avoiding incorrect wiring and combination of the devices. The diagnostic function ensures that the connection between the sensor and transmitter is correct and functioning properly.

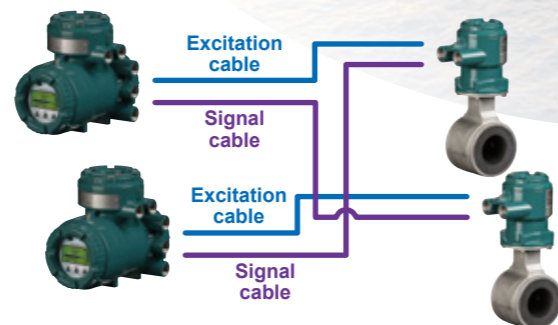

## Wizard function



Eliminate the guesswork. The wizard function helps you set up the transmitter parameter setting step-by-step.

# 02 Expert Guide

## Multiple languages

As a global company, we know we need to speak a number of languages. That's why we have incorporated multiple languages, which are user selectable, into our latest flowmeter.

- English
- French
- German
- Italian
- Spanish
- Portuguese
- Russian
- Chinese
- Japanese



## Data logging function

By using the data logging function, a maximum of 4 different trends or events from 8 different measured variables can be stored on the microSD card at the same time. It is also possible to quickly troubleshoot by exporting recorded trend data and alarm information to PC.

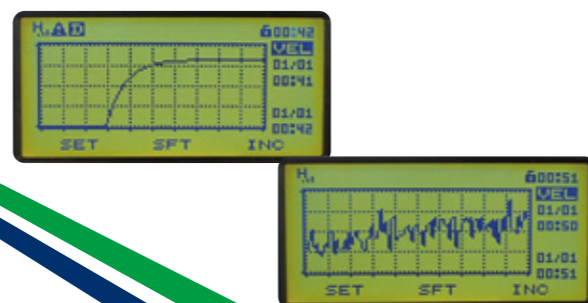

## Variety of verification

Ensuring the correct performance of critical plant instrumentation is costly, time consuming, and can result in lengthy plant downtime. The AXG and AXW verification function allows the health of the flowmeter to be confirmed easily. Verification results can be obtained as a report for maintenance records.

### Verification via display or communication

#### Built-in verification

- Magnetic circuit check
- Excitation circuit check
- Calculation circuit check
- Device status check
- Connection status check
- Physical appearance check



Select the Verification

Execute the Built-in Verification

### Verification with the ADMAG TI Verification Tool (FSA130)

#### Standard verification

- Built-in verification and physical appearance check
- Checking for LCD display (with 4 display patterns)
- Verification result is output as a report

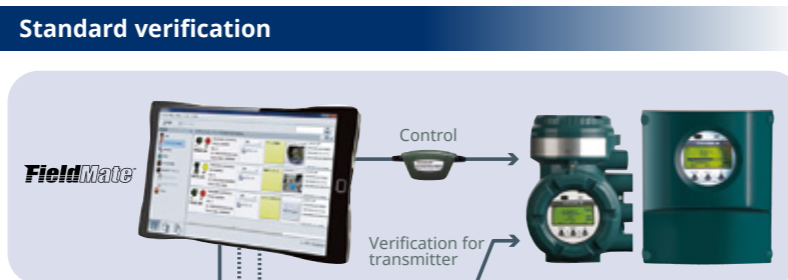

#### Enhanced verification

- Standard verification and additional external verification
- Verification result is output as a report

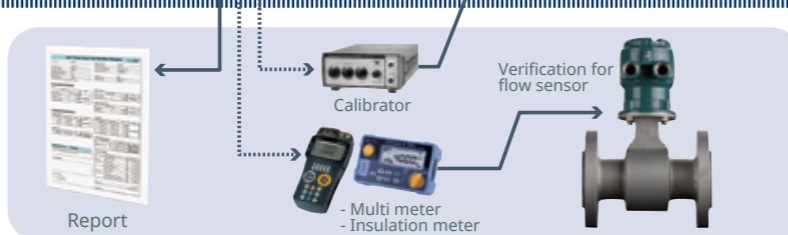

Enhanced verification

## Application diagnostic

Application diagnostic can detect various process conditions of your site by actively utilizing flow noise signal.

- Detection of flow noise (air bubbles, slurry)
- Detection of coil insulation deterioration
- Detection of electrode insulation deterioration
- Detection of fluid conductivity decrease
- Detection of electrode adhesion (insulator)

A stable flow measurement and accurate flow noise detection. (When changing the conductivity of fluid)

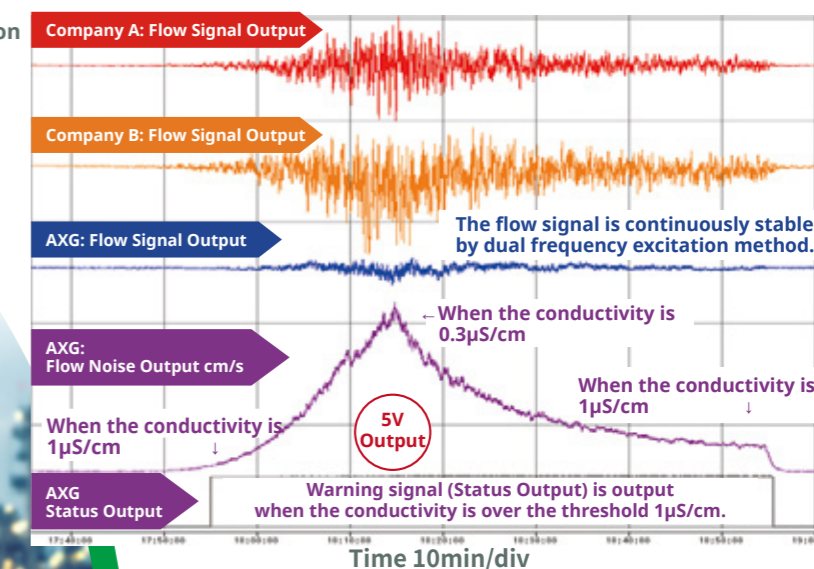

Time 10min/div

03 Process Guard

04 Expert Solution



# 04 Expert Solution



## Available microSD card (Realize easy data transfer)

The ADMAG TI supports microSD card for storing multiple information related to process measurements, device diagnostics, maintenance data and so on.

It can also be used to back up device parameter setting and factory settings which can be restored if required. A removable display also has storage functionality similar to the microSD card. The data mobility provided by the microSD card and removable display helps for easy cloning of parameters to similar devices drastically saving commissioning and start up man hours.

Recorded trend data and alarm information can be exported to PC for ease of troubleshooting.



## Backward compatibility

The ADMAG TI ensures backward compatibility for retrofit. The ADMAG TI transmitters can be paired with earlier generation Yokogawa sensors or even third party flow tubes. This helps to optimize inventory and maximize useful life of existing equipment which results in considerable savings in capital expenditure.

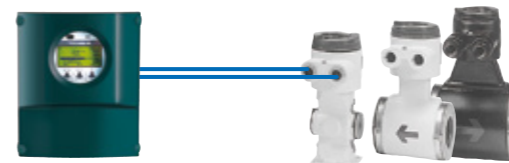

The AXG1A is the successor to the AXFA11, and inherits the placement positions of the input and output terminals and the hole positions for mounting the stanchion. Therefore, it is easy to replace AXFA11 to AXG1A.

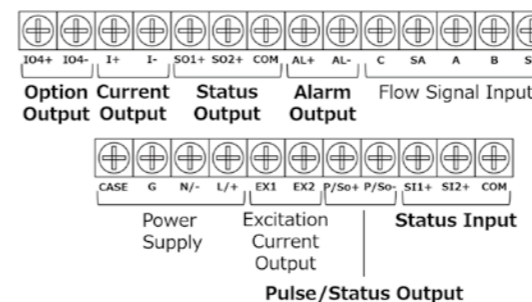

## Various I/O combinations

Whether you have a DCS, PLC, or even just a local controller, the ADMAG TI offers multiple combination of I/O (including current input) and communication types. This gives you the flexibility in receiving the process information as the way you want to.

### Input/Output Signal Terminal

	AXG1A High grade Transmitter	AXG4A Transmitter AXG Integral Type	AXW4A Transmitter AXW Integral Type	CA Integral type
Current Output	●	●	●	●
Current Input	●	●	—	—
Pulse/Status Output	●	●	●	●
Status Output	●	●	—	—
Status Input	●	●	●	●
Alarm Output	●	—	—	—

### Communication Protocol

	AXG1A High grade Transmitter	AXG4A Transmitter AXG Integral Type	AXW4A Transmitter AXW Integral Type	CA Integral type
HART7	●	●	●	●
BRAIN	●	●	●	—
Modbus	—	●	●	—
FOUNDATION Fieldbus	—	●	●	—
PROFIBUS PA	—	●	●	—
EtherNet/IP	—	●	●	—

## Worldwide approvals

There are a number of approvals required in various regions throughout the world. To meet the needs of all markets and applications, the ADMAG TI offers multiple communication protocols, explosion proof, SIL (Safety Integrity Level IEC61508), EMC, NAMUR, marine certificate and hygiene standards.





# Simplified Selection



## Specification of transmitters

	AXG1A Transmitter	AXG4A Transmitter	AXW4A Transmitter	CA Integral type flowmeter
Sensor combination (AXG/AXW)	AXG, AXW 2.5 to 1800mm	AXG 2.5 to 400mm	AXW 25 to 1000mm	CA 15 to 200mm
Dual frequency excitation	2.5 to 400mm	2.5 to 400mm	25 to 400mm	N/A
LCD	4 lines display (Max 8 lines with scroll)	4 lines display (Max 8 lines with scroll)	4 lines display (Max 8 lines with scroll)	4 lines display (Max 8 lines with scroll)
microSD card data storage	Yes (Option)	Yes (Option)	Yes (Option)	Yes (Option)
Self-diagnostic (Adhesion, Empty pipe)	Yes	Yes	Yes	N/A
Built-in verification	Yes	Yes	Yes	Yes
Standard/Enhanced Verification with FieldMate	Yes (with FSA130)	Yes (with FSA130)	Yes (with FSA130)	Yes (with FSA130)
Application diagnostic	Yes (Low conductivity, Bubble, Slurry etc)	Yes (Low conductivity, Bubble, Slurry etc)	N/A	N/A
Explosion protection use	N/A	Japan, IECEx, ATEX, USA (FM), Canada (FMc), Korea, Brazil (INMETRO), EAC	IECEx, ATEX, Korea, Brazil (INMETRO), EAC	Coming soon (Japan, IECEx, ATEX, USA (FM))

	AXG1A Transmitter	AXG4A Transmitter	AXW4A Transmitter	CA Integral type flowmeter
Current, Pulse, Status Output (max. channel) (Note 1)	Current 2ch Pulse/Status 2ch	Current 2ch Pulse/Status 3ch	Current 1ch Pulse/Status 2ch	Current 1ch Pulse/Status 2ch
Status input (Note 1)	2ch (Independent)	1ch (Selectable)	1ch (Selectable)	1ch (Selectable)
Current input for process temperature (For calc. Calorie, Density correction) (Note 1)	1ch	1ch (Selectable)	N/A	N/A
Intrinsically safe output	N/A	HART 7, BRAIN, FOUNDATION Fieldbus, PROFIBUS PA	N/A	N/A
Multiple languages	9 Languages	9 Languages	9 Languages	9 Languages
Communication protocols	HART 7, BRAIN	HART 7, BRAIN, Modbus, FOUNDATION Fieldbus, PROFIBUS PA, EtherNet/IP	HART 7, BRAIN, Modbus, FOUNDATION Fieldbus, PROFIBUS PA, EtherNet/IP	HART7
Safety Integrity Level	N/A	SIL2	SIL2	N/A
Combine with AXF flow sensor	Yes	Yes	N/A	—
Signal Cable Length (max)	200m	100m	100m	—

Note 1 : The combinations of current input/output, pulse output and status input/output depend on selections of communication and input/output suffix code.

# Simplified Selection



## Specification of Flow sensors

	AXG Flow sensor	AXW Flow sensor	CA Integral type flowmeter
Size	2.5 to 500mm	25 to 1800mm	15 to 200mm
Liner material	Ceramics, PFA	PTFE, Polyurethane rubber, Natural hard rubber, Natural soft rubber	Ceramics
General purpose use	Yes	Yes	Yes
Explosion protection use	Japan, IECEx, ATEX, USA (FM), Canada (FMc), Korea, Brazil (INMETRO), EAC	IECEx, ATEX, Korea, Brazil (INMETRO), EAC	Coming soon (Japan, IECEx, ATEX, USA (FM))
Hygienic use	Yes	N/A	N/A
Submersible use	Yes	Yes	N/A
Standard accuracy *	± 0.3% of rate	± 0.35% of rate	± 0.5% of rate
High accuracy *	± 0.15% of rate 25 to 200mm	N/A	N/A
Electrode type	Wetted	Wetted	Non-wetted
Measurable fluid conductivity	1μS/cm or larger	1μS/cm or larger	0.01μS/cm or larger
Wider flare area (Upgrade sealing reliability)	PFA	N/A	N/A
ASME Class 600 Flange (For high pressure application)	25 to 100mm	N/A	N/A
500mm PFA liner	Yes	N/A	N/A
Built-in grounding electrodes	150 to 400mm Platinum-Iridium, Tantalum	N/A	N/A

\*Factory calibrated result

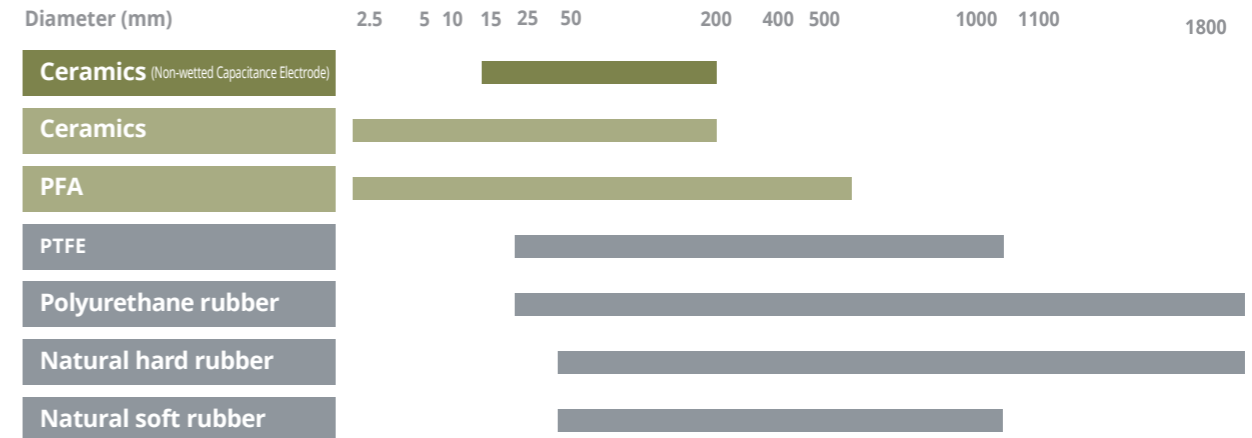

### CA

- Lining: Ceramics (Non-wetted Capacitance Electrode)
- Size coverage is 15mm to 200mm

### AXG

- The liner materials are ceramics and PFA with variety of electrode materials
- Size coverage is 2.5mm to 500mm

### AXW

- The liner materials are PTFE, Polyurethane rubber, Natural soft rubber, Natural hard rubber with stainless steel and nickel alloy electrodes
- Size coverage is 25mm to 1800mm (Integral type is up to 1000mm)

## Superior liner Materials for AXG

### Alumina Ceramics

- Anti corrosive material
- Anti abrasive material
- For Chemical, Pulp&Paper and Mining
- Temp range:-10 to 180 °C
- The CA uses a non-wetted capacitive electrode, making it particularly resistant to slurry fluids and insulator-adhering fluid.



### Fluorocarbon PFA

- Anti corrosive material
- For chemical industry
- Temp range: -40 to 160 °C

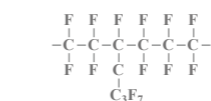
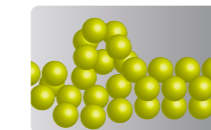

## Cost effective liner Materials for AXW

### Fluorocarbon PTFE

- Anti corrosive material
- For chemical industry
- Temp range: -10 to 130 °C

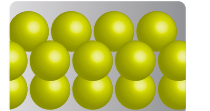

### Polyurethane rubber

- Anti-abrasive material
- For general use (water application)
- Temp range: -10 to 40 °C



### Natural hard rubber (Ebonite)

- Anti corrosive material
- For oily waste water
- Temp range:-5 to 80 °C

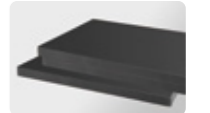

### Natural soft rubber

- Anti abrasive material
- For mining industry and so on
- Temp range: -10 to 70 °C

