

**AQ2200 series**

# **Multi Application Test System**

## **Data sheet**

## Frame Controller (AQ2211 / AQ2212)

Items		Specifications	
Product name		AQ2211	AQ2212
Number of slots		3	9
Display		Color LCD, 320 × 240 dots	
Remote interface	GPIB	IEEE-488 compatible, protocol: IEEE-488.2 compatible	
	Ethernet	IEEE802.3 compatible, connector: RJ-45 x 1, transmission method: Ethernet (100BASE-TX), protocol: TCP/IP	
	USB	USB Rev1.1 compatible, connector: USB type B x 1, protocol: USB-TMC <sup>*1</sup>	
External storage interface		USB (USB Rev2.0 compatible, connector: USB type A x 1, applicable device: USB mass storage class flash memory)	
Trigger	In	Connector: BNC x 1, TTL level, Pulse width: 50 μs or more, Impedance: approx. 5 kΩ	
	Out	Connector: BNC x 1, TTL level, Pulse width: approx. 50 μs, Impedance: approx. 100 Ω	
Interlock connector		BNC connector	
Functions	Preset applications	Stability, Logging, Optical return loss (ORL)	
	Control functions	Macro programming, Multi-user, Remote viewer support	
Operation environment	Ambient temperature	5 to 40°C	
	Ambient humidity	20 to 80% RH (no condensation)	
	Altitude	2000 m or less	
Storage environment	Ambient temperature	-20 to 60°C	
	Ambient humidity	20 to 80% RH (no condensation)	
	Altitude	3000 m or less	
Power requirement		100 to 240 Vac, 50/60 Hz	
Power Consumption (including modules)		170 VA	580 VA
Dimensions (excluding protrusions)		Approx. 212(W) × 132.5(H) × 400(D) mm	Approx. 425(W) × 132.5(H) × 500(D) mm
Mass		Approx. 6 kg	Approx. 11 kg
Safety standard		EN 61010-1, Overvoltage category (installation category) II, Pollution degree 2	
Emissions		EN 61326-1 class A, EN 55011 class A group 1, EN 61000-3-2, EN 61000-3-3	
Immunity		EN 61326-1 Table 2 (for industrial locations)	
Recommended calibration period		1 year (include modules)	

\*1 A separate driver is required.

## LS Module (AQ2200-112)

Items	Specifications
Number of channel	1 or 2 channels
Device type	DFB-LD
Center Wavelength <sup>*1, *2, *3, *5</sup>	1310 nm ±5 nm, 1550 nm ±5 nm, 1625 nm ±5 nm, 1650 nm ±5 nm
Optical output level <sup>*1, *2, *3, *6</sup>	+10 dBm or more
Output level stability (5 minutes) <sup>*1, *2, *4, *6</sup>	±0.005 dB
Spectral linewidth <sup>*1, *2, *7</sup>	Narrow: 10 MHz (typ.) Wide: 100 MHz (typ.)
SMSR <sup>*1, *2, *3, *5</sup>	35 dB or more
RIN <sup>*1, *2, *3, *5, *7</sup>	-135 dB/Hz (typ.)
Attenuation range <sup>*1, *4, *6</sup>	6 dB (resolution 0.01 dB (typ.))
Fiber type	SMF (ITU-T G.652)
Optical connector	FC/Angled PC
Dimensions (excluding protrusions)	Approx. 31(W) × 117(H) × 321.5(D) mm, 1-slot wide
Mass	Approx. 0.8 kg
Laser safety standard class	Class 1 (IEC60825-1:2014), Class 1 (EN 60825-1:2014+A11:2021)

\* After 30 minutes warm up.

\* The environmental conditions are subject to the specification of frame controller, unless otherwise specified.

\*1 When a SM fiber is used.

\*2 At maximum output power

\*3 Ambient temperature: 23±2°C

\*4 At constant temperature (within ±0.5°C)

\*5 Spectral linewidth: Narrow

\*6 Spectral linewidth: Wide

\*7 Characteristics

### ●Laser Safety Information

This laser light source is a Class 1 laser product as defined by IEC 60825-1:2014 Safety of Laser Products—Part 1: Equipment Classification and Requirements. In addition, this instrument complies with 21 CFR 1040.10 and 1040.11 except for conformance with IEC 60825-1 Ed.3., as described in Laser Notice No. 56, dated May 8, 2019.



**Laser class 1 label**

Avoid direct eye exposure.

## Grid TLS Module (AQ2200-131 / -132)

Items	Specifications
Number of channel	AQ2200-131: 1, AQ2200-132: 2
Device type	Advanced type (-T6)
Frequency band	C-band L-band
Frequency (Wavelength) range	196.25 to 191.50 THz (1527.60 to 1565.50 nm) 190.95 to 186.35 THz (1570.01 to 1608.76 nm)
Grid spacing	100 GHz, 50 GHz, 25 GHz and Manual (min. 0.1 GHz)
Frequency (Wavelength) setting resolution	0.1 GHz (0.8 pm@1550 nm)
Frequency (Wavelength) fine turning range	±6 GHz (typ.)(±48 pm@1550 nm) ±6 GHz (typ.)(±51 pm@1590 nm)
Frequency (Wavelength) fine turning resolution	1 MHz (typ.)(8 fm@1550 nm) 1 MHz (typ.)(8 fm@1590 nm)
Absolute frequency (wavelength) accuracy <sup>*1, *2, *4, *6</sup>	±2.5 GHz (±20 pm@1550 nm) ±2.5 GHz (±21 pm@1590 nm)
Frequency (Wavelength) stability 24hours <sup>*1, *2, *3, *6</sup>	±0.3 GHz (typ.)(2.4 pm@1550 nm) ±0.3 GHz (typ.)(2.5 pm@1590 nm)
Frequency (Wavelength) tuning time <sup>*5</sup>	30 sec. or less
Optical output level <sup>*1, *2, *4, *6</sup>	+12.5 dBm or more
Attenuation range	6 dB (resolution: 0.01 dB(typ.))
Output level stability 24hours <sup>*1, *2, *3, *6</sup>	±0.03 dB (typ.)
Spectral linewidth <sup>*6</sup>	100 kHz (typ.)
SMSR <sup>*6</sup>	45 dB (typ.)
RIN <sup>*6, *7</sup>	-145 dB/Hz (typ.)
Fiber type	PANDA PMF, Slow axis, in line with connector key
Optical connector	Select any of FC/PC <sup>*8</sup> or FC/Angled PC <sup>*9</sup>
Dimensions (excluding protrusions)	Approx. 31(W) × 117(H) × 321.5(D) mm, 1-slot wide
Mass	Approx. 0.8 kg
Laser safety standard class	Class 1M (IEC 60825-1:2007, GB 7247.1-2012), Class 1 (EN 60825-1:2014+A11:2021)

\* After 30 minutes warm up.

\* The environmental conditions are subject to the specification of frame controller, unless otherwise specified.

\* 1 When a PM fiber is used.

\* 2 At grid mode on. A grid spacing is except a manual setting.

\* 3 At constant temperature (within ±0.5°C)

\* 4 Ambient temperature: 23±5°C

\* 5 Setting by frequency (wavelength) fine

turning function is not included.

\* 6 At maximum output power

\* 7 20 MHz to 10 GHz

\* 8 Optical return loss: 40 dB or more

\* 9 Step type, narrow key

### ●Laser Safety Information

This laser light source is classified into "IEC60825-1: 2007; Class 1M". This specification complies with "21CFR 1040.10" except for deviation points arising from strict observation of "Laser Notice No. 50" issued on June 24, 2007.

**Laser class 1M label**

Using an optical instrument, such as a loupe, magnifying glass, or microscope, when observing the laser beam from a distance of less than 100 mm may cause eye injury.



## Sensor Module (AQ2200-212 / -222 / -215)

Items		Specifications		
Product name		AQ2200-212	AQ2200-222	AQ2200-215
Number of channels		1	2	1
Detector type		InGaAs		
Wavelength range		800 to 1700 nm		970 to 1660 nm
Power range (CW light)		-90 to +15 dBm <sup>*1,*2</sup>		-70 to +30 dBm
Minimum display resolution		1/10,000		
Applicable fiber <sup>*3</sup>		≤62.5/125 μm (GI), NA≤0.275		
Uncertainty under reference conditions		±2.5% <sup>*4</sup>		±3% <sup>*5</sup>
Total uncertainty		±5% ±5 pW <sup>*6</sup>		±5% ±2 nW <sup>*7,*15</sup>
Polarization dependence		0.02 dBp-p (typ.) <sup>*8</sup>		0.03 dBp-p (typ.) <sup>*9</sup>
Linearity		±0.02 dB ±5 pW <sup>*10</sup>		±0.05 dB ±2 nW <sup>*11,*15</sup>
Noise level		5 pW or less <sup>*12</sup>		2 nW or less <sup>*13</sup>
Averaging time (minimum)		100 μs		
Analog output	Mode	AUTO, LINEAR, LOG		AUTO, LINEAR, LOG
	Output voltage	Approx. 0 to 2 V / 0 to 5 V		Approx. 0 to 2 V
	Connector type	BNC		Mini plug
	Output impedance	Approx. 100 Ω		Approx. 1 kΩ
Optical connector		AQ9335C (*) connector adapter <sup>*14</sup>		
Logging function	Measurement power range	Fixed		
	Minimum data sampling interval	100 μs		
	Maximum number of data samples	20000		
Stability function	Minimum data sampling interval	100 ms		
	Maximum number of data samples	20000		
	Maximum measurement time	99 days		
Dimensions (excluding protrusions)		Approx. 31(W) × 117(H) × 321.5(D) mm, 1slot wide		
Mass		Approx. 0.8 kg	Approx. 0.9 kg	Approx. 0.7 kg

- \* All values in the specifications assume a warm-up period of one hour.
- \* The environmental conditions are subject to the specification of frame controller, unless otherwise specified.
- \* 1 At 1310 nm
- \* 2 When hold range is set, maximum +11 dBm when auto range is set.
- \* 3 When the AQ9335C(\*) Connector Adapter is used.
- \* 4 Wavelength: 1310±20 nm, optical fiber: SM (ITU-T G.652), light source spectrum width: 10 nm or less, ambient temperature: 23±2°C, optical fiber: SM (ITU-T G.652), optical connector: FC/PC, wavelength setting error: 0.5 nm or less, changes to the measuring instrument due to the passage of time are not included in these conditions. More than 1 year but less than 2 years since the last calibration: add 0.5%, over 2 years: add 1.0%, averaging: 1 sec, polarization dependence is not included.
- \* 5 Wavelength: 1310±20 nm, optical fiber: SM (ITU-T G.652), light source spectrum width: 10 nm or less, ambient temperature: 23±2°C, optical fiber: SM (ITU-T G.652), optical connector: FC/PC, wavelength setting error: 0.5 nm or less, changes to the measuring instrument due to the passage of time are not included in these conditions. Add 0.5% for each year since the last calibration.
- \* 6 Power level: 10 mW to 100 nW (-40 dBm to +10 dBm), CW light, wavelength range: 1200 to 1600 nm, optical fiber: SM (ITU-T G.652)(add ±1% if GI 50/125 (ITU-T G.651.1), add ±9% if GI 62.5/125 (IEC 60793-2)), auto range, Other condition are the same as \*4's conditions.

- \* 7 Power level: 1 μW at 1 W (-30 dBm to +30 dBm), CW light, wavelength range: 1260 to 1620 nm, optical fiber: ≤50 GI, NA ≤0.2 (add ±2% if 62.5 GI, NA ≤0.275), auto range, averaging: 1 sec. Other conditions are the same as \*5's conditions.
- \* 8 Wavelength: 1550±30 nm, ambient temperature: 23±1°C, optical fiber: SM (ITU-T G.652), optical connector: FC/PC
- \* 9 Wavelength: 1550±30 nm, ambient temperature: 23±2°C, optical fiber: SM (ITU-T G.652), optical connector: FC/PC
- \* 10 Power level: 10 mW to 100 nW (-40 dBm to +10 dBm), CW light, wavelength range: 1200 to 1600 nm, ambient temperature: 23±1°C (constant temperature), optical fiber: SM (ITU-T G.652), auto range, averaging: 1 sec
- \* 11 Power level: 1 μW to 1 W (-30 dBm to +30 dBm), CW light, wavelength range: 1260 to 1620 nm, ambient temperature: 23±2°C (constant temperature), optical fiber: SM (ITU-T G.652), auto range, averaging: 1 sec
- \* 12 Wavelength: 1200 to 1600 nm, ambient temperature: 23±1°C (constant temperature), averaging: 1 sec, within 5 minutes after zero set execution.
- \* 13 Wavelength range: 1260 to 1620 nm, ambient temperature: 23±2°C (constant temperature), averaging: 1 sec
- \* 14 Select FC, SC, LC, or MU
- \* 15 Add 0.001 dB/mW if the input power is greater than 10 mW.

## Optical Sensor Head (AQ2200-232 / -242)

Items		Specifications	
Product name		AQ2200-232	AQ2200-242
Number of channels		1	
Detector type		InGaAs 5 mm dia.	Si □5.8 mm
Wavelength range		800 to 1700 nm	400 to 1100 nm
Power range (CW light)		-90 to +15 dBm <sup>*1,*2</sup>	-90 to +10 dBm
Minimum display resolution		1/10,000	
Applicable fiber <sup>*3</sup>		≤62.5/125 μm (GI), NA≤0.275	
Uncertainty under reference conditions		±1.8% <sup>*4,*6</sup>	±2.5% <sup>*5,*6</sup>
Total uncertainty		±5% ±5 pW <sup>*7,*9</sup>	±5% ±5 pW <sup>*8,*9</sup>
Polarization dependence		0.025 dB (typ.) <sup>*10</sup>	—
Linearity		±0.015 dB ±5 pW <sup>*11,*13,*14</sup>	±0.04 dB ±5 pW <sup>*12,*13,*15</sup>
Noise level		5 pW or less <sup>*16</sup>	5 pW or less <sup>*17</sup>
Averaging time (minimum)		100 μs	
Optical connector <sup>*18</sup>		AQ9335C(*) connector adapter	
Recommended calibration period		1 year	
Dimensions (excluding protrusions)		Approx. 61(W) × 46(H) × 100(D) mm	
Mass		Approx. 0.3 kg	

- \* All values in the specifications assume a warm-up period of one hour.
- \* The environmental conditions are subject to the specification of frame controller, unless otherwise specified.
- \* 1 At 1310 nm
- \* 2 When hold range is set, maximum +11 dBm when auto range is set.
- \* 3 When the AQ9335C(\*) Connector Adapter is used. It is also possible to measure free-space light by removing the connector adapter.
- \* 4 Wavelength: 1310±20 nm, optical fiber: SM (ITU-T G.652) NA=0.1, polarization dependence is not included
- \* 5 Wavelength: 850±15 nm, optical fiber: SM (850 nm SMF)
- \* 6 Power level: 100 μW (-10 dBm), CW light, light source spectrum width: 10 nm or less, ambient temperature: 23±2°C, optical connector: FC/PC, averaging: 1 sec, wavelength setting error: 0.5 nm or less, changes to the measuring instrument due to the passage of time are not included in these conditions. More than 1 year but less than 2 years since the last calibration: add 0.4%, over 2 years: add 0.8%.
- \* 7 Wavelength: 1000 to 1630 nm, polarization dependence is not included
- \* 8 Wavelength: 500 to 900 nm (900 to 1000 nm: add ±2%)
- \* 9 Power level: 1 nW to 10 mW (-60 dBm to +10 dBm), CW light, light source spectrum width: 10 nm or less, ambient temperature: 23±5°C, optical fiber: GI50 NA0.2 (add ±1% if GI62.5 and NA0.275), optical connector: FC/PC, averaging: 1 sec, auto range, wavelength setting error:

- 0.5 nm or less, changes to the measuring instrument due to the passage of time are not included in these conditions. More than 1 year but less than 2 years since the last calibration: add 0.4%, over 2 years: add 0.8%.
- \* 10 Wavelength: 1550 nm, ambient temperature: 23±2°C, optical fiber: SM (ITU-T G.652) NA=0.1, optical connector: FC/PC
- \* 11 Wavelength: 1000 to 1630 nm, optical fiber: SM (ITU-T G.652) NA=0.1
- \* 12 Wavelength: 500 to 900 nm, beam condition: SM (850 nm SMF), GI50 NA=0.2 or GI62.5 NA=0.275
- \* 13 Power level: 1 nW to 10 mW (-60 dBm to +10 dBm), CW light, ambient temperature: 23±2°C (constant temperature), auto range, averaging: 1 sec, optical connector: FC/PC
- \* 14 For free-space light measurement, the power density of the light-detecting surface is 30 mW/mm<sup>2</sup> or less.
- \* 15 For free-space light measurement, the power density of the light-detecting surface is 5 mW/mm<sup>2</sup> or less.
- \* 16 Wavelength: 1000 to 1630 nm, ambient temperature: 23±2°C (constant temperature), averaging: 1 sec, within 5 minutes after zero set execution
- \* 17 Wavelength: 500 to 900 nm, ambient temperature: 23±2°C (constant temperature), averaging: 1 sec, within 5 minutes after zero set execution
- \* 18 Select FC, SC, LC, or MU

## Interface Module (AQ2200-202)

Items		Specifications	
Number of channels		2	
Analog output	Mode	AUTO, LINEAR, LOG	
	Output voltage	Approx. 0 to 2 V / Approx. 0 to 5 V	
	Output impedance	Approx. 100 Ω	
	Connector type	BNC connector	
Logging function	Measurement power range	Fixed	
	Minimum data sampling interval	100 μs	
	Maximum number of data samples	20,000	
Stability function	Minimum data sampling interval	100 ms	
	Maximum number of data samples	20,000	
	Maximum measurement time	99 days	
Dimensions (excluding protrusions)		Approx. 31(W) × 117(H) × 321.5(D) mm 1 slot wide	
Mass		Approx. 0.5 kg	

## ATTN Module (AQ2200-312 / -332)

Items	Specifications			
	AQ2200-312		AQ2200-332	
Product name	AQ2200-312		AQ2200-332	
Wavelength range	1200 to 1700 nm	800 to 1370 nm	1200 to 1700 nm	800 to 1370 nm
Insertion loss <sup>*2</sup>	1.0 dB (typ.) <sup>*1,*3,*4</sup> 1.6 dB or less <sup>*1,*3</sup>	1.0 dB (typ.) <sup>*4</sup> 1.6 dB or less <sup>*11</sup>	1.9 dB (typ.) <sup>*1,*3,*5</sup>	1.9 dB (typ.) <sup>*5,*11</sup>
Maximum attenuation	60 dB	45 dB	60 dB	45 dB
Attenuation accuracy <sup>*2</sup>	±0.1 dB or less <sup>*3,*6,*7</sup>	±0.1 dB or less <sup>*9</sup>	±0.1 dB or less <sup>*3,*6,*7</sup>	±0.1 dB or less <sup>*9</sup>
Repeatability <sup>*2</sup>	±0.01 dB or less <sup>*1,*8</sup>	±0.01 dB or less <sup>*8,*9</sup>	±0.01 dB or less <sup>*1,*8</sup>	±0.01 dB or less <sup>*8,*9</sup>
Display resolution	0.001 dB			
Output monitor accuracy	—		±5% or less <sup>*2,*10,*12,*14</sup>	±5% or less <sup>*2,*14,*16</sup>
Optical return loss	45 dB or more <sup>*3,*6,*13</sup>	20 dB or more <sup>*9</sup>	45 dB or more <sup>*3,*6,*13</sup>	20 dB or more <sup>*9</sup>
Polarization dependence	0.08 dBp-p or less <sup>*3,*6</sup>	—	0.1 dBp-p or less <sup>*3,*6</sup>	—
Maximum input power	+23 dBm	—	+23 dBm	—
Shutter isolation	90 dB or more			
Applicable optical fiber	SMF (ITU-T G.652)	Select any of MMF (GI 50/125) (ITU-T G651.1) or MMF (GI 62.5/125) (IEC 60793-2)	SMF (ITU-T G.652)	Select any of MMF (GI 50/125) (ITU-T G651.1) or MMF (GI 62.5/125) (IEC 60793-2)
Optical connector	Select any of FC/PC or SC/PC			
Monitor port option	—			
Monitor port output <sup>*15</sup>	−13 dB (typ.) <sup>*1,*2,*3</sup>	−13 dB (typ.) <sup>*2,*9</sup>	—	
Insertion loss <sup>*2</sup>	2.3 dB or less <sup>*1,*3</sup>	2.3 dB or less <sup>*11</sup>	—	
Polarization dependence	0.1 dBp-p or less <sup>*3,*6</sup>	—	—	
Dimensions (excluding protrusions)	Approx. 31(W) × 117(H) × 321.5(D) mm, 1slot wide			
Mass	Approx. 0.9 kg			

- \* All values in the specifications assume a warm-up period of one hour. Unless otherwise noted, all specified values include connectors.
- \* For models with MMF specifications, all specified values are guaranteed when a light source that is excited in steady mode is used.
- \* The environmental conditions are subject to the specification of frame controller, unless otherwise specified.
- \* 1 Wavelength: 1550±15 nm, 1310±15 nm
- \* 2 Ambient temperature: 23±2°C (constant temperature)
- \* 3 When using the Yokogawa reference master cord (SMF)
- \* 4 Connectors not included
- \* 5 Connectors not included. 2.3 dB or less when connectors are included.

- \* 6 wavelength: 1550±15 nm
- \* 7 0.15 dB or less if the wavelength is 1310±15 nm
- \* 8 2 σ
- \* 9 Wavelength: 850 nm, 1310 nm
- \* 10 Polarization dependence is not included.
- \* 11 Wavelength: 850 nm. Add 0.5 dB if the wavelength is 1310 nm.
- \* 12 Any one wavelength within 1310±15 nm or 1550±15 nm
- \* 13 When using PC connectors (return loss 48 dB or more)
- \* 14 Output power: -10 dBm
- \* 15 Output ratio
- \* 16 Wavelength: 850 nm

## OSW Module (AQ2200-411 / -412 / -421)

Items	Specifications								
	AQ2200-411				AQ2200-412		AQ2200-421		
Port configuration	1 × 4	1 × 8	1 × 4	1 × 8	1 × 16	1 × 2	2 × 2	1 × 2	2 × 2
Number of switch	1					2			
Wavelength	1310 nm/1550 nm		850 nm/1310 nm		1310 nm/1550 nm	850 nm/1310 nm	1310 nm/1550 nm		850 nm/1310 nm
Insertion loss <sup>*3,*5</sup>	1.0 dB (typ.) <sup>*1,*4</sup>		1.0 dB (typ.) <sup>*2</sup>		1.0 dB (typ.) <sup>*1,*4</sup>	1.0 dB (typ.) <sup>*2</sup>	1.0 dB (typ.) <sup>*1,*4</sup>		1.0 dB (typ.) <sup>*2</sup>
Repeatability <sup>*3,*6</sup>	±0.01 dB or less <sup>*1</sup>		±0.01 dB or less <sup>*2</sup>		±0.01 dB or less <sup>*1</sup>	±0.01 dB or less <sup>*2</sup>	±0.01 dB or less <sup>*1</sup>		±0.01 dB or less <sup>*2</sup>
Crosstalk	−60 dB or less <sup>*1,*4</sup>		−50 dB or less <sup>*2</sup>		−60 dB or less <sup>*1,*4</sup>	−50 dB or less <sup>*2</sup>	−50 dB or less <sup>*1,*4</sup>		−50 dB or less <sup>*2</sup>
Optical return loss	45 dB or more <sup>*1,*4,*7</sup>		20 dB or more <sup>*2</sup>		45 dB or more <sup>*1,*4,*7</sup>	20 dB or more <sup>*2</sup>	45 dB or more <sup>*1,*4,*7</sup>		20 dB or more <sup>*2</sup>
Maximum input power	+23 dBm		—		+23 dBm	—	—		—
Polarization dependence	0.08 dBp-p or less <sup>*1,*4</sup>		—		0.08 dBp-p or less <sup>*1,*4</sup>	—	0.08 dBp-p or less <sup>*4,*8</sup>		—
Applicable optical fiber	SMF (ITU-T G.652)		Select any of MMF (GI 50/125) (ITU-T G651.1) or MMF (GI 62.5/125) (IEC 60793-2)		SMF (ITU-T G.652)	MMF (GI 50/125) (ITU-T G651.1)	SMF (ITU-T G.652)		Select any of MMF (GI 50/125) (ITU-T G651.1) or MMF (GI 62.5/125) (IEC 60793-2)
Optical connector	Select any of FC/PC or SC/PC								
Dimensions (excluding protrusions)	Approx. 31(W) × 117(H) × 321.5(D) mm, 1 slot wide				Approx. 62.5(W) × 117(H) × 321.5(D) mm, 2 slots wide		Approx. 31(W) × 117(H) × 321.5(D) mm, 1 slot wide		
Mass	Approx. 0.8 kg				Approx. 1.5 kg		Approx. 0.7 kg		

- \* All values in the specifications assume a warm-up period of one hour. Unless otherwise noted, all specified values include connectors.
- \* For models with MMF specifications, all specified values are guaranteed when a light source that is excited in steady mode is used.
- \* The environmental conditions are subject to the specification of frame controller, unless otherwise specified.
- \* 1 Wavelength: 1310±15 nm, 1550±15 nm

- \* 2 Wavelength: 850 nm, 1310 nm
- \* 3 Ambient temperature: 23±2°C (constant temperature)
- \* 4 When using the Yokogawa reference master cord (SMF)
- \* 5 Connectors not included. 1.4 dB or less when connectors are included.
- \* 6 2 σ
- \* 7 When using PC connectors (return loss 48 dB or more)
- \* 8 Wavelength: 1550±15 nm

# Transceiver I/F Module (AQ2200-642)

## ●Monitoring Specifications

Name	Rating		Measurement Range			Accuracy *1
	Upper	Lower	Upper	Lower	Resolution	
Power supply voltage monitor	PS1	+7.5 V	-0.5 V	+6 V	+2 V	1 mV ±(0.2% of reading+1 mV)
	PS2	+7.5 V	-0.5 V	+4 V	+2 V	
	PS3	+7.5 V	-0.5 V	+2.5 V	+0.5 V	
	PS4	-7.5 V	+0.5 V	-2 V	-6 V	
	PS5	+7.5 V	-0.5 V	+6 V	+2 V	
Power supply current monitor	PS1			1.8 A	0 A	1 mA ±(1% of reading+2 mA)
	PS2			3 A	0 A	
	PS3	-		1.8 A	0 A	
	PS4			3 A	0 A	
	PS5			2 A	0 A	
Status signal monitor	AIN1	+7.5 V	-0.5 V	+6 V	+0 V	0.01 V ±(1% of reading+20 mV)
	AIN2					
	AIN3					
	AIN4					
	AIN5					
	AIN6					
Resistance value monitor	R1	-		10000 Ω	0 Ω	1 Ω ±(0.5% of reading +2 Ω)
Power consumption monitor	PSPOWER	-		28 W	0 W	0.1 W See the values for the voltage and current monitors.

## ●Power Supply Specifications

Name	Voltage Range	Current Limit Range
PS1	+4.750 to +5.250 V	0.10 to 1.80 A
PS2	+3.135 to +3.465 V	0.10 to 3.00 A
PS3	+0.800 to +1.890 V	0.10 to 1.80 A
PS4	-5.460 to -4.940 V	0.10 to 3.00 A
PS5	5.0 or 3.3 V	0.10 to 1.00 A (when 5.0 V is selected)
		0.10 to 2.00 A (when 3.3 V is selected)

## ●Control Signal Transmission Specifications

Items	Specifications	
DC response		
CTRL01 (1.2 V) to CTRL07 (1.2 V)	VOL max	0.2 V (100 μA), 0.3 V (1 mA)
	VOH min	1.0 V (100 μA), 0.9 V (1 mA)
	IOL max	+1 mA
	IOH mini	-1 mA
CTRL08 (3.3 V) to CTRL17 (3.3 V)	VOL max	0.5 V (3 mA)
	VOH min	2.5 V (3 mA)
	IOL max	+3 mA
	IOH mini	-3 mA

## ●I<sup>2</sup>C Bus Signal Specifications

Items	Specifications	
Signal rate	100 kHz/400 kHz	
DC response		
SDA	VOL max	0.5 V
	VOH min	-(Open Drain)
	IOL max	+3 mA
	IOH max	-(Open Drain)
	VIL max	0.7 V
	VIH max	1.7 V
SCL	VOL max	0.5 V
	VOH min	-(Open Drain)
	IOL max	+3 mA
	IOH max	-(Open Drain)
	VIL max	0.7 V
	VIH max	1.7 V

## ●MDIO Bus Signal Specifications

Items	Specifications	
Signal rate	625 kHz/1.25 MHz/2.5 MHz	
DC response		
MDIO	VOL max	0.35 V
	VOH min	-(Open Drain)
	IOL max	+3 mA
	IOH max	-(Open Drain)
	VIL max	0.2 V
	VIH max	1.0 V
MDC	VOL max	0.35 V
	VOH min	0.85 V (3 mA)
	IOL max	+3 mA
	IOH max	+3 mA
	VIL max	-
	VIH max	-

## ●General Specifications

Items	Specifications
Dimensions (excluding protrusions)	Approx. 62.5(W) × 117(H) × 321.5(D) mm, 2 slots wide
Mass	Approx. 1.5 kg

\* The environmental conditions are subject to the specification of frame controller, unless otherwise specified.

\*1 Ambient temperature: 23±2°C, warm-up period: 20 minutes

# Front view

AQ2211/2212 Frame Controller

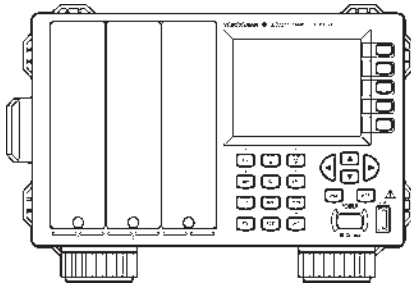

AQ2211

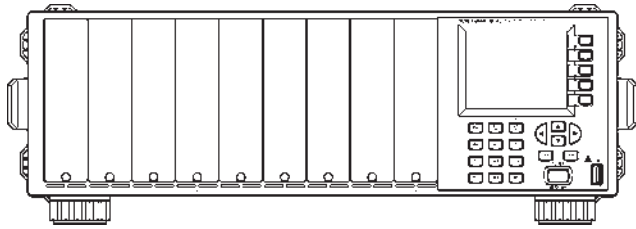

AQ2212

AQ2200-112  
LS Module

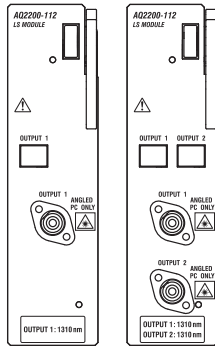

AQ2200-131/-132  
Grid TLS Module

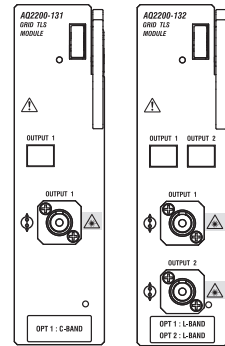

AQ2200-131

AQ2200-132

AQ2200-212  
Sensor Module

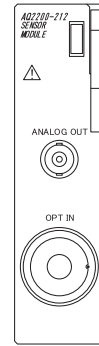

AQ2200-222  
Dual Sensor Module

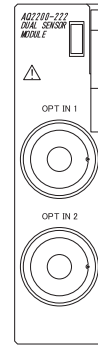

AQ2200-215  
Sensor Module



AQ2200-202  
Interface Module

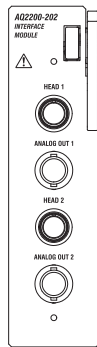

AQ2200-232  
Optical Sensor Head

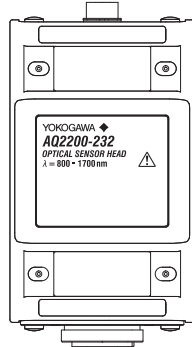

AQ2200-242  
Optical Sensor Head

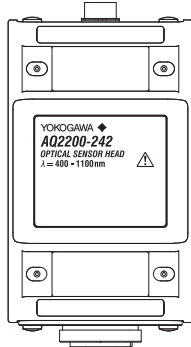

AQ2200-312  
ATTN Module

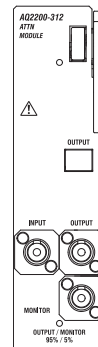

AQ2200-332  
ATTN Module

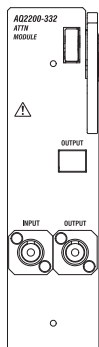

AQ2200-411  
OSW Module

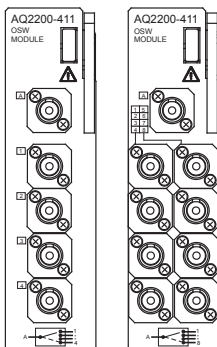

AQ2200-412  
OSW Module

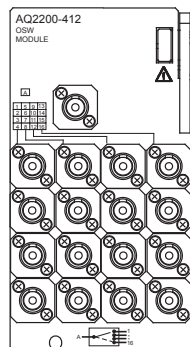

AQ2200-421  
OSW Module

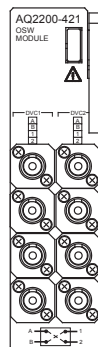
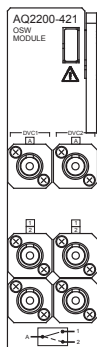

AQ2200-642  
Transceiver I/F Module

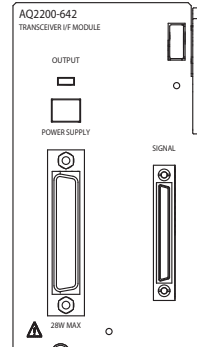

# External Dimensions

Unit: mm  
Tolerances: ±3 % (tolerances are ±0.3 mm when below 10 mm)

AQ2211 Frame Controller

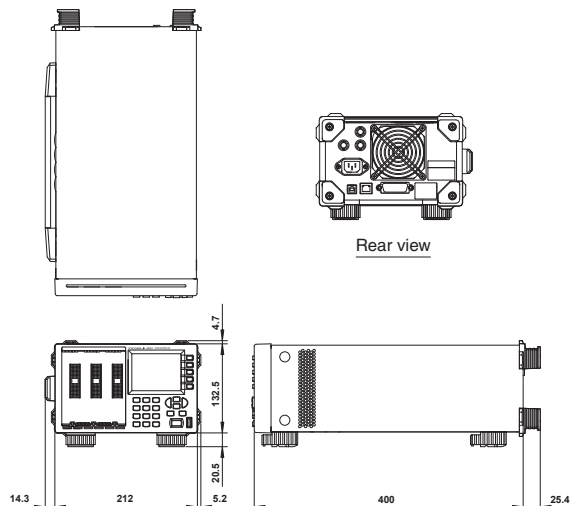

AQ2212 Frame Controller

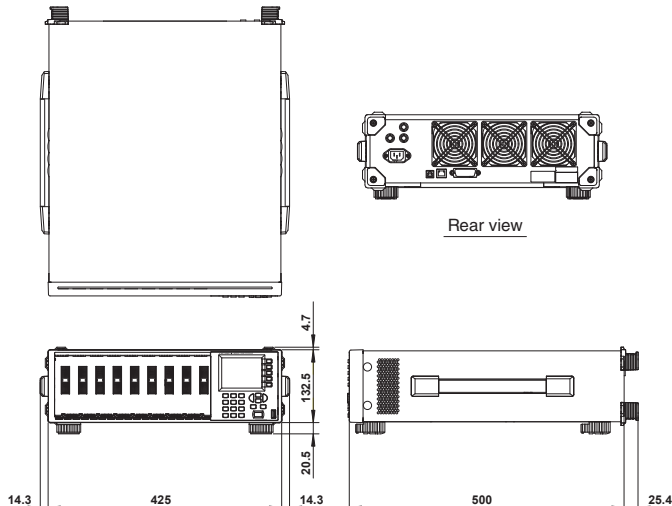

AQ2200 Series 1-Slot Size Module

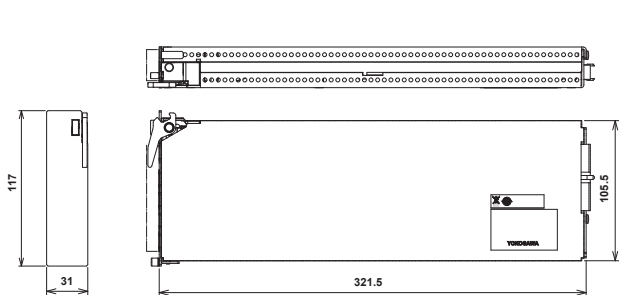

AQ2200 Series 2-Slot Size Module

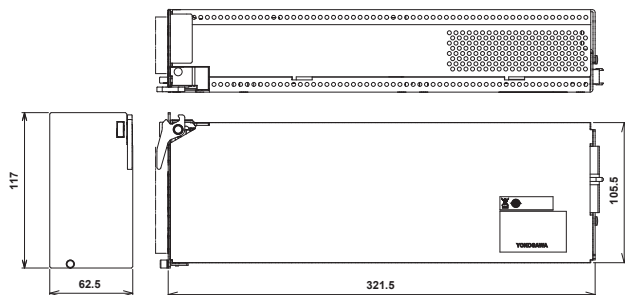

AQ2200-232 / -242 Optical Sensor Head

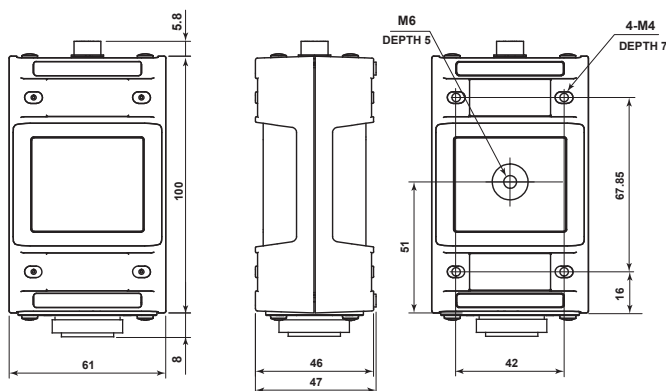

Microsoft, MS, and Windows are registered trademarks or trademarks of Microsoft Corporation in the US and other countries.  
Ethernet is a registered trademark of Xerox Corporation. All other company names and product names mentioned herein are registered trademarks or trademarks of their respective holders.  
This is a Class A instrument based on Emission standards EN61326-1 and EN55011, and is designed for an industrial environment. Operation of this equipment in a residential area may cause radio interference, in which case users will be responsible for any interference which they cause.

**Caution**



When you export this product out of Japan, permission from the Japanese government may be required in accordance with the regulations of the foreign exchange and foreign trade laws.  
The information contained herein is subject to change without prior notice in order to improve performance and quality.



<https://tmi.yokogawa.com/> YMI-N-MI-M-E03

**YOKOGAWA TEST & MEASUREMENT CORPORATION**  
Global Sales Dept. /E-mail: tm@cs.jp.yokogawa.com

The contents are as of February 2024. Subject to change without notice.  
Copyright © 2012, Yokogawa Test & Measurement Corporation  
[Ed: 09/b] Printed in Japan, 403(KP)

**YOKOGAWA CORPORATION OF AMERICA**  
**YOKOGAWA EUROPE B.V.**  
**YOKOGAWA TEST & MEASUREMENT (SHANGHAI) CO., LTD.**  
**YOKOGAWA ELECTRIC KOREA CO., LTD.**  
**YOKOGAWA ENGINEERING ASIA PTE. LTD.**  
**YOKOGAWA INDIA LTD.**  
**YOKOGAWA ELECTRIC CIS LTD.**  
**YOKOGAWA AMERICA DO SUL LTDA.**  
**YOKOGAWA MIDDLE EAST & AFRICA B.S.C(c)**

<https://tmi.yokogawa.com/us/>  
<https://tmi.yokogawa.com/eu/>  
<https://tmi.yokogawa.com/cn/>  
<https://tmi.yokogawa.com/kr/>  
<https://tmi.yokogawa.com/sg/>  
<https://tmi.yokogawa.com/in/>  
<https://tmi.yokogawa.com/ru/>  
<https://tmi.yokogawa.com/br/>  
<https://tmi.yokogawa.com/bh/>