

**PH4/OR4 Sensor Series  
pH and ORP Sensors**

IM 12B10B00-01EN

---

# Introduction

Thank you for purchasing the PH4/OR4 Sensor Series pH and ORP Sensors.

Please read the following respective documents before installing and using the sensors.

This manual is applied to the following sensors;

PH4P	Polymer Electrolyte pH Sensor
PH4PT	Polymer Electrolyte pH Sensor with RTD
OR4P	Polymer Electrolyte ORP Sensor
PH4F	HF-Resistant pH Sensor
PH4FT	HF-Resistant pH Sensor with RTD
PH4C	pH Sensor for Chemical Process
PH4CT	pH Sensor for Chemical Process with RTD
OR4C	ORP Sensor for Chemical Process
PH4FE	pH Sensor for Fermentation

Other relevant models are described in the following manuals.

Equipment	Model	Model name	Manual
<b>Holder</b>	PH8HS	Submersion type holder	IM 12B07M01-E
	PH8HF	Flow-through type holder	
<b>Adapter</b>	—	(Option code)	(this manual)
	SA405	Adapter with temperature sensor	
<b>Transmitter</b>	FLXA202, FLXA21	2-Wire Analyzer	IM 12A01A02-01E etc.
	FLXA402	4-Wire Converter	IM 12A01F01-02EN IM 12A01F02-01EN etc.
	PH450G	pH/ORP Converter	IM 12B07C05-01E
<b>Terminal box</b>	WTB10	Terminal box	IM 19D01B01-01E
<b>Distributor</b>	PH201G	Distributor	IM 19B01E04-02E
	VJA1, MA1, etc.	Distributor	IM 77J01A01-01E, IM 77J04A01-01E etc.
<b>Accessories</b>	PH8AX	Accessories for pH meter	IM 12B07W03-01E
	OR8AX	Accessories for ORP meter	IM 12C04W02-01E

Check the following when you receive the product:

- Appearance
- Model Name (on nameplate of sensor) and Suffix Codes (on nameplate of packing box)

If you have any questions, contact our sales representative or your local distributor.

## ■ Notes on Handling User's Manuals

- Please hand over the user's manuals to your end users so that they can keep the user's manuals on hand for convenient reference.
- Please read the information thoroughly before using the product.
- The purpose of these user's manuals is not to warrant that the product is well suited to any particular purpose but rather to describe the functional details of the product.
- No part of the user's manuals may be transferred or reproduced without prior written consent from YOKOGAWA.
- YOKOGAWA reserves the right to make improvements in the user's manuals and product at any time, without notice or obligation.
- If you have any questions, or you find mistakes or omissions in the user's manuals, please contact our sales representative or your local distributor.
- Some drawings may be partially emphasized, simplified, or omitted, for the convenience of description.

# Safety Precautions

## ■ Safety, Protection, and Modification of the Product

- In order to protect the system controlled by the product and the product itself and ensure safe operation, observe the safety precautions described in this user's manual. We assume no liability for safety if users fail to observe these instructions when operating the product.
- If this instrument is used in a manner not specified in this user's manual, the protection provided by this instrument may be impaired.
- If any protection or safety circuit is required for the system controlled by the product or for the product itself, prepare it separately.
- Be sure to use the spare parts approved by Yokogawa Electric Corporation (hereafter simply referred to as YOKOGAWA) when replacing parts or consumables.
- Modification of the product is strictly prohibited.
- The following words are used in this manual.

### CAUTION

This symbol gives information essential for understanding the operations and functions.

### NOTE

This symbol indicates information that complements the present topic.

## ■ Warning and Disclaimer

The product is provided on an "as is" basis. YOKOGAWA shall have neither liability nor responsibility to any person or entity with respect to any direct or indirect loss or damage arising from using the product or any defect of the product that YOKOGAWA can not predict in advance.

## ■ Compliance with the simple apparatus requirements

PH4/OR4 sensor series meets the simple apparatus requirements defined in the following standards.

Note1: PH4P, PH4PT, OR4P, PH4F, PH4FT, PH4C, PH4CT, OR4C, and PH4FE can be applied as simple apparatus.

Note2: For PH4PT, PH4FT, and PH4CT classification of intrinsic safety, and electrical parameters are approved by TIIS, which is valid in only Japan.

Use the sensors under the conditions of use required by the standards.

### Applicable standards:

- ANSI/ISA-60079-11 (2014)
- ANSI/ISA-60079-0 (2009)
- CAN/CSA-C22.2 NO. 60079-11:14
- CAN/CSA-C22.2 NO. 60079-0:11
- 한국 전자파적합성 기준
- GB 3836.4-2010

### Conditions of use:

- (1) Use with an internally isolated transmitter, or use with a transmitter in combination with isolated barrier.  
The FLXA21/202 is internally isolated.
- (2) Upper limit of the process temperature.  
The upper limit of process temperature is indicated below when the sensor is used in combination with a YOKOGAWA transmitter.

For FLXA21/202, model and suffix code below is available.

FLXA21-D-□-D-◇-P1-○-A-N-LA-N-NN

□ can be any value.

◇ must be EA, CD, CH, or EG

○ must be NN or P1.

Any option code is available.

FLXA202-D-□-D-◇- P1-○-A-N-LA-N-NN

□ can be any value.

◇ must be CD, CH, or CG

○ must be NN or P1.

Any option code is available.

For PH202S, model and suffix code below is available.

PH202S-○-E

○ must be C or U.

There are no PH202S models that meet the Korean explosion proof standards.

Any option code is available.

Upper limit of process temperature (Ambient temperature : -20°C to +40°C)

Transmitter used in combination Sensor type Temp. class	FLXA21/202				PH202S			
	PH4P OR4P	PH4F	PH4C OR4C	PH4FE*	PH4P OR4P	PH4F	PH4C OR4C	PH4FE *
T6	55	55	55	55	75	75	75	75
T5	70	70	70	70	90	80	90	90
T4	105	80	100	105	105	80	100	105
T3	105	80	100	105	105	80	100	105
T2	105	80	100	105	105	80	100	105
T1	105	80	100	105	105	80	100	105

\*: Do not use beyond upper limit of process temperature at sterilization.

Transmitter used in combination Sensor type Temp. class	FLXA21/202			PH202S		
	PH4PT	PH4FT	PH4CT	PH4PT	PH4FT	PH4CT
T6	NA*	NA*	NA*	22	22	22
T5	65	65	65	82	80	82
T4	100	80	100	110	80	100
T3	100	80	100	110	80	100
T2	100	80	100	110	80	100
T1	100	80	100	110	80	100

\*: Not allowed to be installed in T6.

## CAUTION

Handling precaution:

IEC60079-14 (Electrical installations in hazardous areas) requires a label indicating “simple apparatus.” Stick this label to this sensor if necessary.



PH4/OR4 Sensor Series  
pH and ORP Sensors

IM 12B10B00-01EN 7th Edition

## CONTENTS

Introduction .....	i
Safety Precautions .....	ii
1. Application .....	1
2. Specifications .....	2
3. Model and Suffix Codes .....	3
4. Wiring Diagrams .....	8
5. Dimensions .....	9
6. Use .....	12
6.1 Preparing .....	12
6.2 Electrical wiring .....	12
6.3 Procedure for Assembling of Sensor into Holder .....	13
6.4 Storage .....	14
6.5 Regenerating .....	14
6.6 General .....	14
Revision Record .....	15



# 1. Application

## ● Selection of pH sensor

Application	pH sensor			
	PH4P PH4PT	PH4F PH4FT	PH4C PH4CT	PH4FE
General purpose*1	—	—	—	—
Contaminated solutions	R	N	N	N
Solutions containing sulfide ion	R	N	L	L
Electrolytic process solutions	N	N	R	N
Solutions containing organic solvents	L	N	R	R
Waste water containing hydrofluoric acid *2	N	R	N	N
Fermentation (sterilization process)	N	N	N	R

R: Recommended, L: Limited, N: Not Applicable

\*1: Refer to GS 12B07B02-E.

\*2: Confirm the specifications of hydrofluoric acid concentration upper limit.

Note: The information in the table above is for reference purpose only. Consult our sales personnel about selection of pH sensor.

## ● Selection of ORP sensor

Application	ORP sensor	OR4P	OR4C
		Platinum	Platinum
General purpose*1		—	—
Drainage treatment	Cyanogen treatment	N	N
	Chrome treatment	N	N
Contaminated solutions*2		L	L
Solutions containing sulfide ion		R	L
Electrolytic process solutions		N	R

R: Recommended, L: Limited, N: Not Applicable

\*1: Refer to GS 12B07B02-E.

\*2: If contaminations are easy to precipitate on OR4P's platinum wire, select OR4C with platinum ring.

Note: This table above is just for reference purpose only. Consult our sales personnel about selection of pH sensor.



## 2. Specifications

	PH4P	PH4PT	OR4P	PH4F	PH4FT	PH4C	PH4CT	OR4C	PH4FE
<b>Measuring range</b>	pH 2 to 14		-1500 to +1500 mV	pH 2 to 11 *1		pH 0 to 14		-1500 to +1500 mV	pH 0 to 12
<b>Measuring temperature *2</b>	0 to 110°C			0 to 80°C		0 to 100°C			0 to 105°C (Sterilization temperature: maximum 130°C)
<b>Measuring pressure *2</b>	Atmospheric pressure to 1.6MPa (Temperature 25°C) Atmospheric pressure to 600kPa (Temperature 100°C)					Atmospheric pressure to 250kPa *3			
<b>Inner solution in reference electrode</b>	Polymer electrolyte including KCl *4					High viscosity gel including KCl			Viscous 3M KCl-LR
<b>Silver ion trap in reference electrode</b>	None					Available			
<b>Diaphragm</b>	Open junction x 2					Ceramic junction x 1			Ceramic junction x 3
<b>Liquid earth</b>	None								
<b>RTD (Temperature element)</b>	None *5, *6	Pt1000	None	None *5, *6	Pt1000	None *5, *6	Pt1000	None	None *5
<b>Insertion Length</b>	120 mm								120, 200, 250 mm *7
<b>Glass tube diameter</b>	12 mm								
<b>Wetted part material</b>	<b>Body</b>	Glass	Glass, platinum	Glass			Glass, platinum	Glass	
	<b>O-ring *8</b>	Fluororubber (FPM)				Ethylene Propylene Diene Rubber (EPDM)			—
	<b>Adapter</b>	Stainless steel (SUS316) (option code: /S3), Polypropylene (option code: /PP) or Rigid polyvinyl chloride (option code: /PV)				Stainless steel (SUS316) (option code: /S3), Polypropylene (option code: /PP), Rigid polyvinyl chloride (option code: /PV), Heat-resistant Vinyl Chloride (option code: /HPV) or Titanium (option code: /TN)			—
<b>ORP element</b>	—		Pt (Wire)	—			Pt (Ring)	—	
<b>Head form</b>	S8	VP6	S8	S8	VP6	S8	VP6	S8	S7
<b>Cable</b>	S8/S7	VP6	S8/S7		VP6	S8/S7	VP6	S8/S7	
<b>Cable jacket material</b>	Polyvinyl Chloride (PVC)								
<b>Cable measuring temperature</b>	-20 to 70°C	-30 to 70°C	-20 to 70°C		-30 to 70°C	-20 to 70°C	-30 to 70°C	-20 to 70°C	
<b>Applicable holder</b>	Flow-through holder (PH8HF), Submersion holder (PH8HS) *9								*10

Note: Above sensors cannot be used outdoors or with a guide pipe holder.  
Installation from lower position or a horizontal position is not possible. Install to the vertical position of more than 15 degrees against the horizontal position.

\*1: The upper limitation of hydrofluoric concentration is as below.

pH2 Maximum 500 ppm  
pH3 Maximum 1000 ppm  
pH4 Maximum 10000 ppm  
Over pH 5 No upper limitation

\*2: See Table 1 when using with holder (excluding PH4FE)

\*3: PH4C, PH4CT and OR4C are subject to restriction of the inner pressure which remains in the sensor.

\*4: When used in solution contains organic solvents, Polymer may be eroded and cannot be used for long term.

\*5: Select manual temperature compensation on the converter or transmitter.

\*6: Use SA405, an adapter with temperature sensor (RTD), for application where temperature varies.

\*7: Shaft Length in case of PH4FE

\*8: Option code "/PF" Perfluoroelastomer (FFKM) can be selected for O-ring material when used pH sensor (excluding PH4FE).

\*9: An option adapter is needed, but not needed when using SA405, an adapter with temperature sensor (RTD).

Ultrasonic cleaning is not available. Use a holder with jet cleaning equipment when automatic cleaning is necessary.

Use O-ring covered by Teflon (K9148MR) when using a special holder for electrolytic process for PH4C, PH4CT or OR4C.

\*10: PH4FE cannot be used with PH8HF or PH8HS. When a holder is needed, consult our sales personnel.

Table 1 Process Temperature Range, Process Pressure Range

Holder Type	Holder Material	Cleaner	Adapter Material	pH/ORP Range	Temperature (°C)	Process Pressure	
Submersion (PH8HS)	PP, SUS *2	None	PVC	PH4P, PH4PT: pH 2 to 14	0 to 50	Atmospheric pressure (Submersion depth: Max. 3m)	
			PP, SUS *2		0 to 100 *4		
		Provided *3	PVC		0 to 50		
			PP, SUS *2		0 to 80		
Flow-through (PH8HF) *1	PP	None, Provided *3	PVC	PH4F, PH4FT: pH 2 to 11	0 to 50	PH4P, PH4PT, OR4P PH4F, PH4FT: Atmospheric pressure to 500 kPa PH4C, PH4CT, OR4C *5: Atmospheric pressure to 250 kPa	
			PP, SUS *2		0 to 80		
		None	PVC		PH4C, PH4CT: pH 0 to 14		0 to 50
			PP				0 to 80
	SUS *2	None	SUS *2	0 to 100 *4			
			PP, SUS *2	0 to 80			
	Provided *3	None	PVC	OR4P, OR4C: -1500 to 1500 mV	0 to 80		
			PP		0 to 50		
		Provided *3	SUS *2		0 to 80		
			PVC		0 to 50		

PVC: Rigid Polyvinyl Chloride, PP: Polypropylene, SUS: Stainless Steel (SUS316)

\*1: For Flow-through types also refer to temperature and pressure diagram of Holder GS 12J05C02-00E.

\*2: Stainless steel holder and stainless steel adapter should be used if the solution is pH 3 more acidic.

\*3: Only jet cleaning system can be used.

\*4: When PH4F or PH4FT is used, temperature upper limit is 80°C.

\*5: Measurable pressure decreases when the inner pressure of PH4C, PH4CT or OR4C decreases.

### ● Specification for SA405, an adapter with temperature sensor (RTD)

Applicable sensors: PH4P, PH4F, PH4C

Temperature sensor (RTD): Pt1000

Wetted part (Temperature sensor cover/Adapter) materials :

Hastelloy C / Hastelloy C, Stainless steel (SUS316) / PEEK, Titanium / Titanium

Applicable holder: Flow-through holder (PH8HF), Submersion holder (PH8HS)

## 3. Model and Suffix Codes

Model	Suffix Code	Option Code	Specifications
PH4P	.....	.....	Polymer Electrolyte pH Sensor *1
PH4PT	.....	.....	Polymer Electrolyte pH Sensor with RTD *2
PH4F	.....	.....	HF-Resistant pH Sensor *1
PH4FT	.....	.....	HF-Resistant pH Sensor with RTD *2
Insertion Length	-120	.....	120 mm
Cable Length	-00	.....	No Cable *3
	-03	.....	3 m
	-05	.....	5 m
	-10	.....	10 m
	-15	.....	15 m
	-20	.....	20 m
Terminal Type *4	D	.....	Cable for PH400G (Fork Terminal)
	E	.....	Cable for PH202, FLXA202, FLXA21 (Pin Terminal)
	F	.....	Cable for FLXA202, FLXA21 (M4 Ring Terminal)
	G	.....	Cable for FLXA402, PH450G, PH202/TB (M3 Ring Terminal)
	N	.....	No Cable *3
—	-N	.....	Always -N
Option	Adapter *5	/S3	Stainless Steel (SUS316)
		/PP	Polypropylene
		/PV	Rigid Polyvinyl Chloride
		/PF	Perfluoroelastomer (FFKM) *6
	O-Ring		

\*1: PH4P and PH4F can be used with SA405, an adapter with temperature sensor (RTD).

\*2: TIIS Ex intrinsic safety structure (TIIS Ex approval is valid only in Japan)

\*3: When using sensor only, select cable length -00 and Terminal type N.

\*4: When using Terminal box, refer to Table 2.

\*5: This is needed when using the holder PH8HS or PH8HF. However when PH4P or PH4F is used with SA405, an adapter with temperature sensor (RTD), the option adapter is not needed.

\*6: Select perfluoroelastomer when sensor is used in organic solvent, high alkaline or high temperature alkaline solution.

Table 2 Selection of terminal box

Sensor	RTD	SA405	Terminal Type			
			D	E	F	G
PH4P PH4F PH4C	None	Selected	—	WTB10-PH2	WTB10-PH6	WTB10-PH4
		None	—	WTB10-PH1	WTB10-PH5	WTB10-PH3
PH4PT PH4FT PH4CT	Available	—	—	WTB10-PH1	WTB10-PH5	WTB10-PH3
OR4P OR4C	None	—	—	WTB10-PH1	WTB10-PH5	WTB10-PH3
PH4FE	None	—	—	—	—	—

Note: For combined system with WTB10, maximum cable length including sensor cable length should be within 20 m.

Model	Suffix Code	Option Code	Specifications
<b>OR4P</b>	.....	.....	Polymer Electrolyte ORP Sensor
Insertion Length	<b>-120</b>	.....	120 mm
Cable Length	<b>-00</b>	.....	No Cable *1
	<b>-03</b>	.....	3 m
	<b>-05</b>	.....	5 m
	<b>-10</b>	.....	10 m
	<b>-15</b>	.....	15 m
	<b>-20</b>	.....	20 m
Terminal Type *2	<b>D</b>	.....	Cable for PH400G (Fork Terminal)
	<b>E</b>	.....	Cable for PH202, FLXA202, FLXA21 (Pin Terminal)
	<b>F</b>	.....	Cable for FLXA202, FLXA21 (M4 Ring Terminal)
	<b>G</b>	.....	Cable for FLXA402, PH450G, PH202/TB (M3 Ring Terminal)
	<b>N</b>	.....	No Cable *1
—	<b>-N</b>	.....	Always -N
Option	Adapter *3	<b>/S3</b> <b>/PP</b> <b>/PV</b>	Stainless Steel (SUS316) Polypropylene Rigid Polyvinyl Chloride

\*1: When using only sensors, select cable length -00 and Terminal type N.

\*2: When using Terminal box, refer to Table 2.

\*3: This is needed when using the holder PH8HS or PH8HF.

Model	Suffix Code	Option Code	Specifications
<b>PH4C</b>	.....	.....	pH Sensor for Chemical Process *1
<b>PH4CT</b>	.....	.....	pH Sensor for Chemical Process with RTD *2
Insertion Length	<b>-120</b>	.....	120 mm
Cable Length	<b>-00</b>	.....	No Cable *3
	<b>-03</b>	.....	3 m
	<b>-05</b>	.....	5 m
	<b>-10</b>	.....	10 m
	<b>-15</b>	.....	15 m
	<b>-20</b>	.....	20 m
Terminal Type *4	<b>D</b>	.....	Cable for PH400G (Fork Terminal)
	<b>E</b>	.....	Cable for PH202, FLXA202, FLXA21 (Pin Terminal)
	<b>F</b>	.....	Cable for FLXA202, FLXA21 (M4 Ring Terminal)
	<b>G</b>	.....	Cable for FLXA402, PH450G, PH202/TB (M3 Ring Terminal)
	<b>N</b>	.....	No Cable *3
—	<b>-N</b>	.....	Always -N
Option	Adapter *5	<b>/S3</b> <b>/PP</b> <b>/PV</b> <b>/HPV</b> <b>/TN</b> <b>/PF</b>	Stainless Steel (SUS316) Polypropylene Rigid Polyvinyl Chloride Heat-resistant Vinyl Chloride Titanium Perfluoroelastomer (FFKM) *6
	O-Ring		

\*1: PH4C can be used with SA405, an adapter with temperature sensor (RTD).

\*2: TIIS Ex intrinsic safety structure (TIIS Ex approval is valid only in Japan)

\*3: When using sensor only, select cable length -00 and Terminal type N.

\*4: When using Terminal box, refer to Table 2.

\*5: This is needed when using the holder PH8HS or PH8HF. However when PH4P or PH4F is used with SA405, an adapter with temperature sensor (RTD), the option adapter is not needed.

\*6: Select perfluoroelastomer when sensor is used in organic solvent, high alkaline or high temperature alkaline solution.

Model	Suffix Code	Option Code	Specifications
<b>OR4C</b>	.....	.....	ORP Sensor for Chemical Process
Insertion Length	<b>-120</b>	.....	120 mm
Cable Length	<b>-00</b>	.....	No Cable *1
	<b>-03</b>	.....	3 m
	<b>-05</b>	.....	5 m
	<b>-10</b>	.....	10 m
	<b>-15</b>	.....	15 m
	<b>-20</b>	.....	20 m
Terminal Type *2	<b>D</b>	.....	Cable for PH400G (Fork Terminal)
	<b>E</b>	.....	Cable for PH202, FLXA202, FLXA21 (Pin Terminal)
	<b>F</b>	.....	Cable for FLXA202, FLXA21 (M4 Ring Terminal)
	<b>G</b>	.....	Cable for FLXA402, PH450G, PH202/TB (M3 Ring Terminal)
	<b>N</b>	.....	No Cable *1
—	<b>-N</b>	.....	Always -N
Option	Adapter *3	<b>/S3</b> <b>/PP</b> <b>/PV</b> <b>/HPV</b> <b>/TN</b>	Stainless Steel (SUS316) Polypropylene Rigid Polyvinyl Chloride Heat-resistant Vinyl Chloride Titanium

\*1: When using sensor only, select cable length -00 and Terminal type N.

\*2: When using Terminal box, refer to Table 2.

\*3: This is needed when using the holder PH8HS or PH8HF.

Model	Suffix Code	Option Code	Specifications
<b>PH4FE</b>	.....	.....	pH Sensor for Fermentation
Shaft Length	<b>-120</b> <b>-200</b> <b>-250</b>	..... ..... .....	120 mm 200 mm 250 mm
Cable Length	<b>-00</b> <b>-03</b> <b>-05</b> <b>-10</b> <b>-15</b> <b>-20</b>	..... ..... ..... ..... ..... .....	No Cable *1 3 m 5 m 10 m 15 m 20 m
Terminal Type	<b>D</b> <b>E</b> <b>N</b>	..... ..... .....	Cable for PH400G (Fork Terminal) Cable for PH202, FLXA202, FLXA21 (Pin Terminal) No Cable *1
—	<b>-N</b>	.....	Always -N

\*1: When using sensor only, select cable length -00 and Terminal type N.

### ● SA405, adapter with temperature sensor (RTD)

Model	Suffix Code	Option Code	Specifications
<b>SA405</b>	.....	.....	Adapter with temperature sensor
Measuring System	<b>-A</b> <b>-E</b> <b>-F</b> <b>-G</b>	..... ..... ..... .....	for PH400G *1 for PH202/FLXA202/FLXA21 *2 for FLXA202/FLXA21 *4 for FLXA402, PH450G, PH202/TB *3
Material of Temp. Sensor Cover/ Adapter	<b>-HC</b> <b>-S3</b> <b>-TN</b>	..... ..... .....	Hastelloy C / Hastelloy C Stainless steel (SUS316) / PEEK Titanium / Titanium
Cable Length	<b>-03</b> <b>-05</b> <b>-10</b> <b>-15</b> <b>-20</b>	..... ..... ..... ..... .....	3 m 5 m 10 m 15 m 20 m

- \*1: Mark band is shown by alphabet and fork terminals are used.  
 \*2: Mark band is shown by numerals and pin terminals are used.  
 When terminal box is used, select WTB10-PH2.  
 \*3: Mark band is shown by numerals and M3 ring terminals are used.  
 When terminal box is used, select WTB10-PH4.  
 \*4: Mark band is shown by numerals and M4 ring terminals are used.  
 When terminal box is used, select WTB10-PH6.

### ● Spare Parts

Part Name		Part Number	Remarks
Fork Terminal Cable for PH400G, OR400G	3 m	K9691MA	For PH4P, OR4P, PH4F, PH4C, OR4C, PH4FE
	5 m	K9691MB	
	10 m	K9691MC	
	15 m	K9691MD	
	20 m	K9691ME	
Terminal Type: D	3 m	K9691NA	For PH4PT, PH4FT, PH4CT
	5 m	K9691NB	
	10 m	K9691NC	
	15 m	K9691ND	
	20 m	K9691NE	

Part Name		Part Number	Remarks	
Pin Terminal Cable for PH202, FLXA202, FLXA21  Terminal Type: E	3 m	K9691PA	For PH4P, OR4P, PH4F, PH4C, OR4C, PH4FE	
	5 m	K9691PB		
	10 m	K9691PC		
	15 m	K9691PD		
	20 m	K9691PE		
	3 m	K9691QA	For PH4PT, PH4FT, PH4CT	
		5 m		K9691QB
		10 m		K9691QC
		15 m		K9691QD
		20 m		K9691QE
M4 Ring Terminal Cable for FLXA202, FLXA21  Terminal Type: F	3 m	K9691RA	For PH4P,OR4P, PH4F, PH4C, OR4C	
	5 m	K9691RB		
	10 m	K9691RC		
	15 m	K9691RD		
	20 m	K9691RE		
	3 m	K9691RN	For PH4PT, PH4FT, PH4CT	
		5 m		K9691RP
		10 m		K9691RQ
		15 m		K9691RR
		20 m		K9691RS
M3 Ring Terminal Cable for FLXA402, PH450G, PH202/TB  Terminal Type: G	3 m	K9691SA	For PH4P, OR4P, PH4F, PH4C, OR4C	
	5 m	K9691SB		
	10 m	K9691SC		
	15 m	K9691SD		
	20 m	K9691SE		
	3 m	K9691SN	For PH4PT, PH4FT, PH4CT	
		5 m		K9691SP
		10 m		K9691SQ
		15 m		K9691SR
		20 m		K9691SS
Adapter	Stainless Steel (SUS316) Option code: /S3	K9148NA	For PH4P, PH4PT, OR4P, PH4F, PH4FT, PH4C, PH4CT, OR4C	
	Polypropylene Option code: /PP	K9148NB		
	Rigid Polyvinyl Chloride Option code: /PV	K9148NC		
	Heat-resistant Vinyl Chloride Option code: /HPV	K9148ND	For PH4C, PH4CT, OR4C	
	Titanium Option code: /TN	K9148NE		
O-Ring	Perfluoroelastomer (FFKM)	K9319RJ	For PH4P, PH4PT, PH4F, PH4FT, PH4C, PH4CT, Option code: /PF	
	Fluororubber (FPM)	K9691KA	For PH4P, PH4PT, OR4P, PH4F, PH4FT	
	Ethylene Propylene Diene Rubber (EPDM)	K9691KB	For PH4C, PH4CT, OR4C	
Electrolyte	Viscous 3 M KCl-LR	K9691KK	For PH4FE (500mL)	
Buffer solution for calibration (pH4)		K9084LL	Six 250 mL polyethylene bottles	
Buffer solution for calibration (pH7)		K9084LM	Six 250 mL polyethylene bottles	
Buffer solution for calibration (pH9)		K9084LN	Six 250 mL polyethylene bottles	
Powder for buffer solution (pH4)		K9020XA	12 bags, each for preparation of 500 mL	
Powder for buffer solution (pH7)		K9020XB	12 bags, each for preparation of 500 mL	
Powder for buffer solution (pH9)		K9020XC	12 bags, each for preparation of 500 mL	
Reagent for ORP check	Quinhydrone	K9024EC	3 bags, each for preparation of 250 mL	
	Iron	K9024ED	3 bags, each for preparation of 250 mL	

Note: The pH value of the calibrating buffer solution may vary depending on storage conditions.

## 4. Wiring Diagrams

Mark (alphabet / number) of cable core of pH sensor depends on terminal form.

### ● In case of PH4□, PH4FE pH sensor, OR4□ ORP sensor

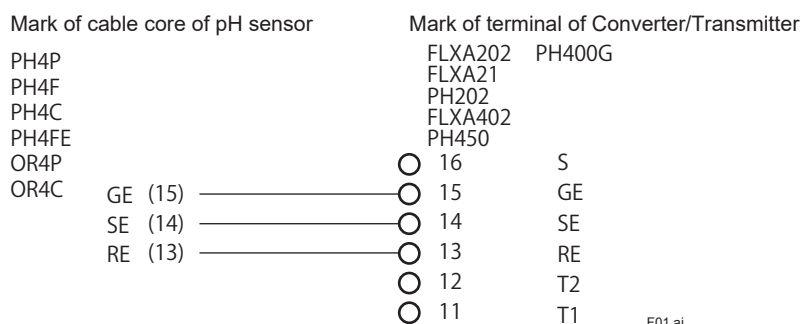

Note: Since RTD is not available, there is no wire connection to Converter/Transmitter 11 (T1) or 12 (T2).  
There is no wire connection to Converter/Transmitter 16 (S).

### ● In case of PH4□T pH sensor with RTD

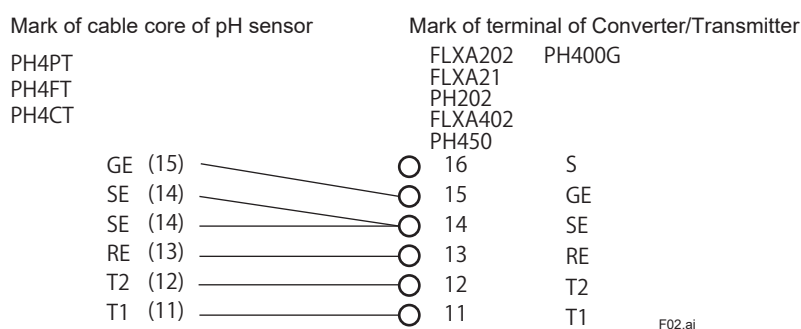

Note: 2 cable cores of pH sensor should be connected to the terminal of Converter/Transmitter 14 (SE).  
There is no wire connection to Converter/Transmitter 16 (S).

### ● When using Terminal box WTB10

No combination with SA405

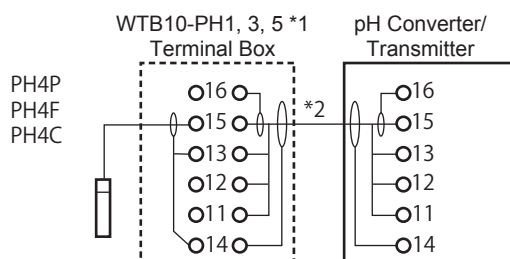

pH sensor with RTD

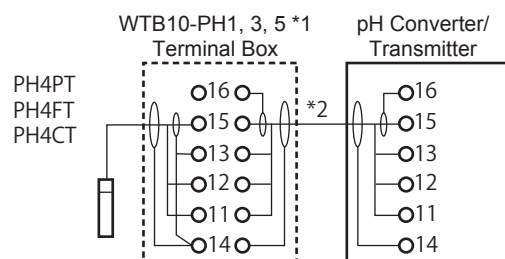

Combination with SA405

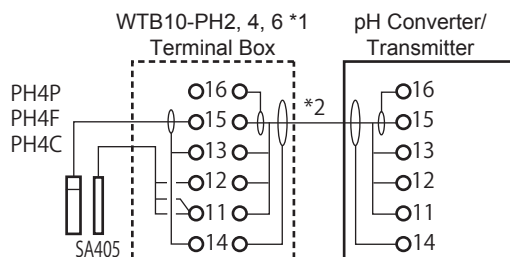

ORP sensor

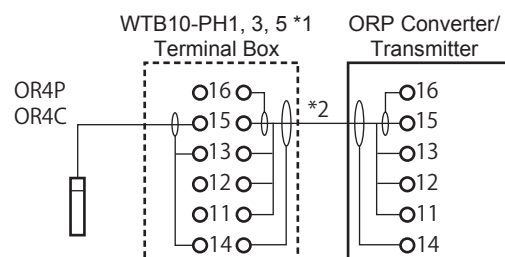

\*1: Terminal box is used only where pH/ORP transmitter is installed remotely from pH or ORP sensor (normally not needed). Refer to Table 2 for WTB10 type.

\*2: This cable is specified in the option code for the terminal box. For combined system with WTB10, maximum cable length including sensor cable length should be within 20m.

## 5. Dimensions

- **PH4P** Polymer Electrolyte pH Sensor
- **PH4F** HF-Resistant pH Sensor
- **PH4C** pH Sensor for Chemical Process

Unit: mm

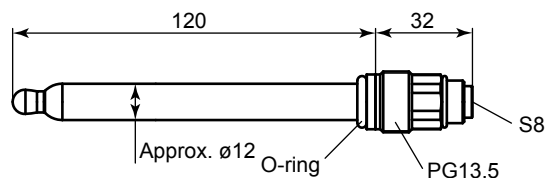

- **PH4PT** Polymer Electrolyte pH Sensor with RTD
- **PH4FT** HF-Resistant pH Sensor with RTD
- **PH4CT** pH Sensor for Chemical Process with RTD

Unit: mm

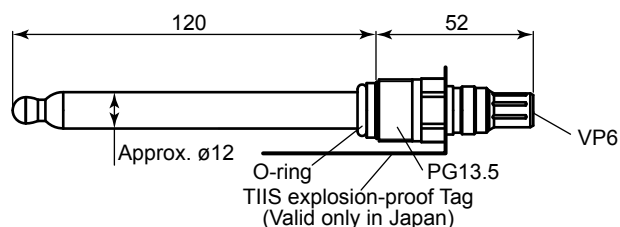

- **OR4P** Polymer Electrolyte ORP Sensor

Unit: mm

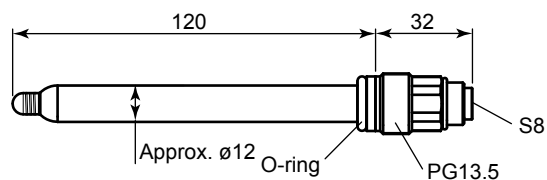

- **OR4C** ORP Sensor for Chemical Process

Unit: mm

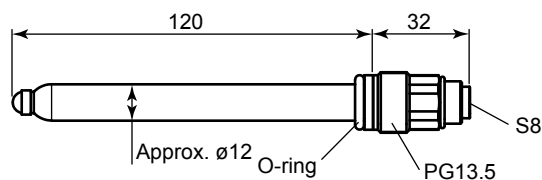



## ■ PH4FE pH Sensor for Fermentation

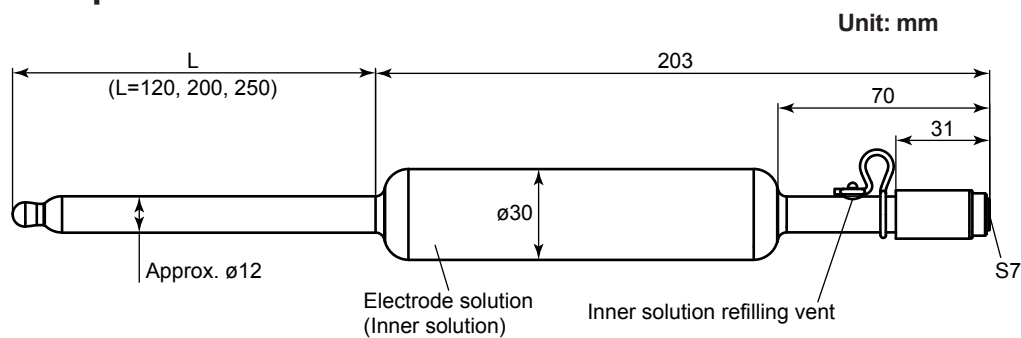

## ● Cable

### S8/S7 cable for PH4P, OR4P, PH4F, PH4C, OR4C, PH4FE

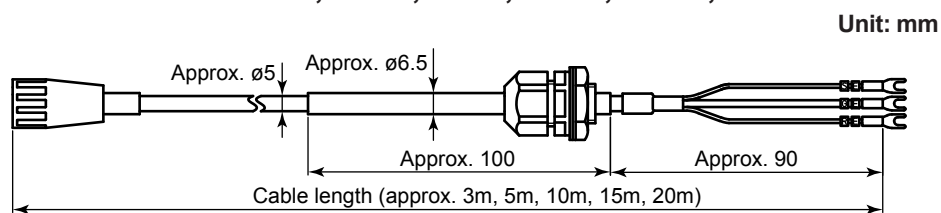

Terminal Type: D

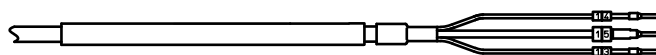

Terminal Type: E

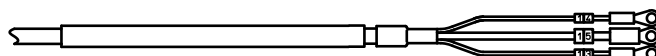

Terminal Type: F, G

Note: There is no terminal type F or G for PH4FE.

## VP6 cable for PH4PT, PH4FT, PH4CT

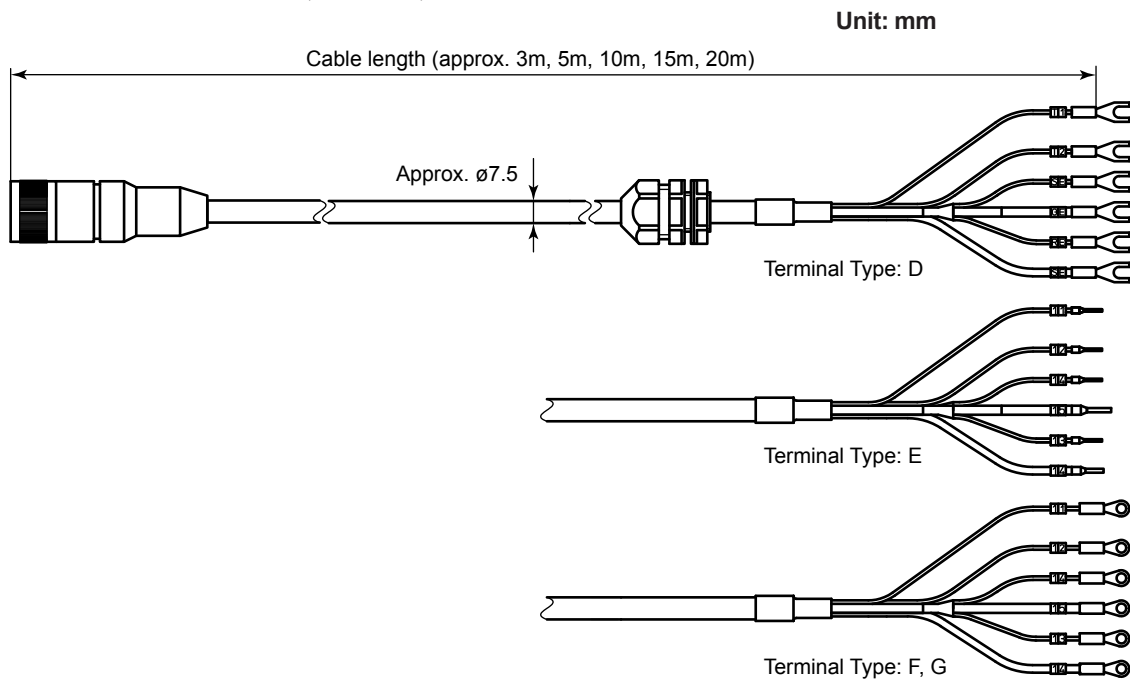

- Adapter (Option code: /S3, /PP, /PV, /HPV, /TN)

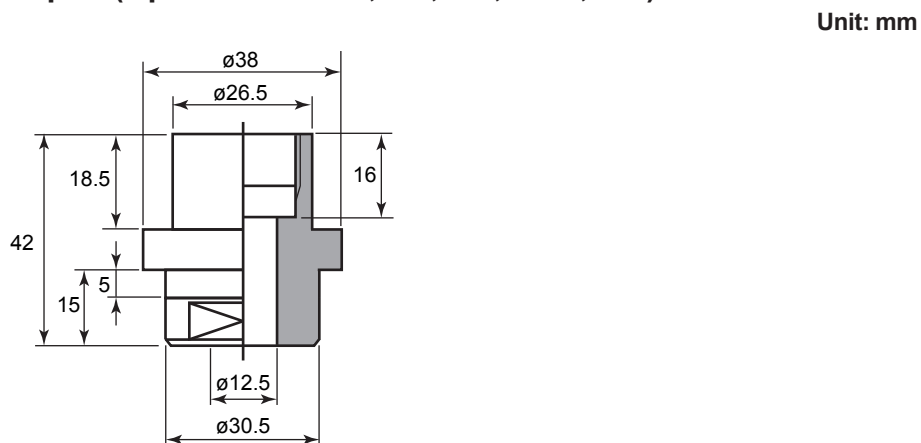

- **SA405, adapter with temperature sensor (RTD)**

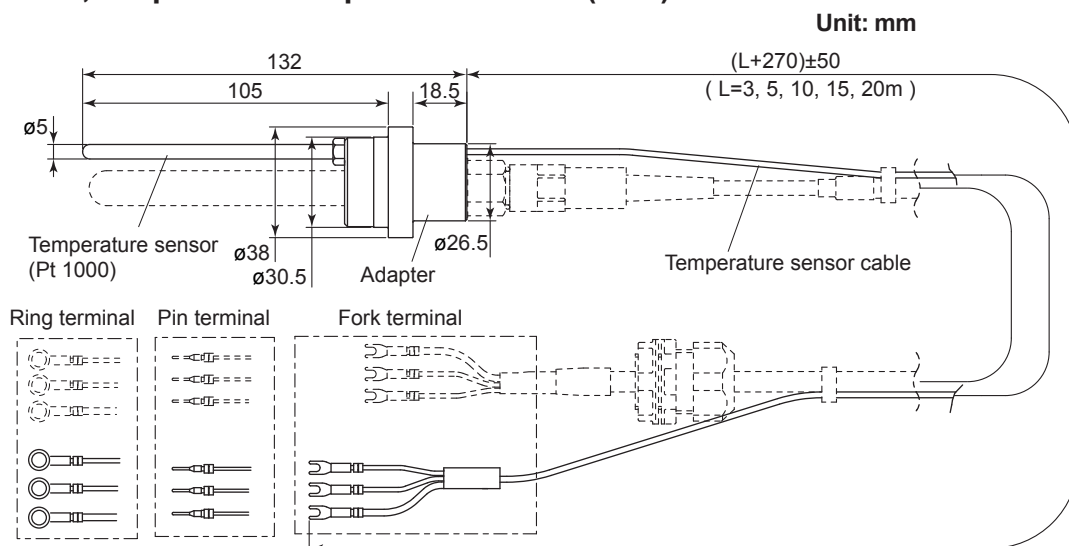

## 6. Use

This sensor is only to be used for the intended purpose and under safe conditions. Improper use or misuse can be dangerous.

### CAUTION

Since these sensors are made of glass, they should be handled with care.

Take care that the PG13.5 thread and the O-ring are not damaged while the sensor is installed into the adapter etc.

### 6.1 Preparing

Carefully remove the storage cap by turning a screw located at a blue gasket. Rinse the sensor with water. Check the interior of the pH glass membrane for air bubbles. Allow any bubbles to rise to the top by shaking the sensor gently.

PH4FE sensor: Prior to measuring, open the reservoir stopper; close it after measuring. Check level of electrolyte in the sensor.

### 6.2 Electrical wiring

The sensors are equipped with a S8, S7 or a VP connector head. Before connecting the sensor to the cable, check that the connections are clean and dry. Do not touch the electrical contacts!

Connectors especially should not be disconnected in moisture condensing environments. Unstable signals, low slope or long response time could indicate a moist or contaminated connector. Clean the connector head with a paper towel moistened with ethanol. Dry the connector head after this procedure with a dry paper towel.

- **Attaching/detaching method of sensor cable**

In case of VP connector

- Rotating the sensor connector so that its recessed portions will agree with the salient portions inside the cable connector, insert the sensor connector into the cable connector. A weak pressure is sufficient for inserting it. If a strong pressure is needed to insert it, the connection position will be incorrect. Check the position and re-try.

- After inserting the sensor connector completely, grip the portion “A”, and rotate the cap nut (“B” portion) clockwise until the nut cannot rotate.
- Gripping the portion “A”, and rotate the cap nut (“B” portion) un-clockwise.
- After loosening the nut completely, grip and pull the plastic portion of the sensor from the cable connector.

## CAUTION

Do not grip or rotate the glass body of the sensor, but the plastic body of the connector.  
If the glass body is gripped, the sensor may be broken.

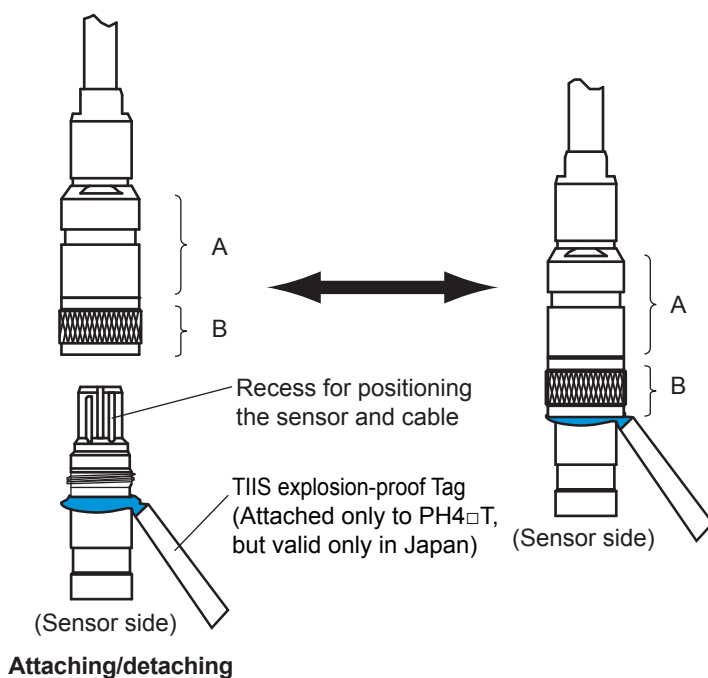

## NOTE

TIIS explosion approval is valid only in Japan, hence users remove TIIS explosion-proof tag and may use PH4□T in hazardous area, or non-hazardous area except Japan.

## NOTE

If conduit is used, the metal part of the cable connector should not be in contact with metal parts of the conduit. If the metal part of the cable connector is in contact with other metal parts, this may cause measurement errors.

## 6.3 Procedure for Assembling of Sensor into Holder

Install a sensor where a cable is connected according to 6.2 in a holder, when a holder is used.

### ● For use of the model PH8HF flow-through holder

- (1) Remove the nut for fixing the sensor to the adapter.
- (2) Pass the cable through the nut.
- (3) Attach the O-ring attached inside the holder, to the adapter. (Refer to the O-ring position in below figure.)
- (4) Put the sensor into the holder, and fix the adapter by screwing the nut.

- **For use of the model PH8HS submersion holder**

- (1) Remove the protector and piece of foam rubber. This rubber is for transportation.
- (2) Pass the O-ring through the cable, and mount it to the upper side of the adapter. (Refer to the O-ring position in below figure.)
- (3) Pass the cable through the holder from the protector attachment side, and fix the sensor by the protector.
- (4) Fix the sensor cable to the holder.

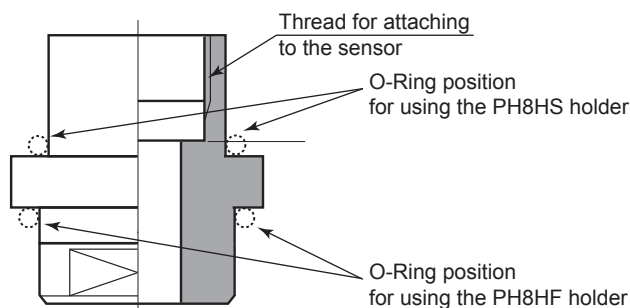

Adapter

## 6.4 Storage

Sensors should be stored with the storage cap attached, containing 1.5 to 2 mL of 3.3 mol/L KCl solution. Sensors stored dry exhibit temporary drifting values. If the sensor dries out inadvertently, it can be placed in 3.3 mol/L KCl solution, or pH standard buffer solution overnight to regenerate.

## 6.5 Regenerating

Entire regenerating is not always guarantee.

pH: Immerse sensor for 10 min in 0.1 – 1M NaOH, then for 10 min in 0.1 – 1M HCl. After regeneration, place the sensor in 3.3 mol/L KCl solution for a further 15 min.

ORP: Metal surfaces can be cleaned with slightly abrasive substances, such as toothpaste or very fine scouring powder.

## 6.6 General

The life cycle of sensors is determined by requirements regarding response time, zero point and slope. Some of harsh measurement conditions might shorten life cycle. There is also a slight ageing factor during storage, therefore avoid a long period of storage. Use within a year is recommended.

O-rings are subject to wear and tear and should be replaced regularly, at least once per year. Refer to “spare parts” regarding the parts number of O-rings.

- **For Models PH4C, PH4CT, OR4C**

The new sensor is pre-pressurized at about 250 kPa. This pressure, after one year, at the liquid junction, will decrease to about half at normal ambient temperatures and atmospheric pressure. Taking this decrease into account, use the sensor. If the pressure of a sample solution becomes higher than the inner pressure of the sensor, the solution will permeate gel electrolyte in the sensor. As a result, the sensor can become unusable.

A rough change of the sensor inner pressure can be known by the air layer length of a narrow tube in the sensor. The higher the internal pressure, the shorter the air layer.

- **For sensors with temperature sensor, RTD (Models PH4PT, PH4FT, PH4CT)**

Sensors with a VP type connection have a built-in temperature sensor (Pt1000). This temperature sensor is to be used only to compensate the pH signal and not to control process temperature.

---

# Revision Record

- Manual Title : PH4/OR4 Sensor Series pH and ORP Sensors
- Manual No. : IM 12B10B00-01EN

**Nov. 2018/7th Edition**

Added FLXA402, correction (pages i, 1, 3 to 8)

**Mar. 2018/6th Edition**

Page 1, the tables of Selection of pH/ORP Sensor were revised.

**Aug. 2017/5th Edition**

TIIS explosion-proof Tag was attached for PH4□T (pages 3, 5, 9, 13)  
Correction (pages i, iii, 4, 5, 6, 7, 8)

**Nov. 2016/4th Edition**

Page iii, the table was corrected.

**Oct. 2016/3rd Edition**

Page iii had an additional table.  
Page 1 tables were revised.  
Page 8 had an additional statement on WTB wiring diagram.

**Jul. 2016/2nd Edition**

Page ii Compliance with the simple apparatus requirements with additional description in CAUTION  
Page 1 the table Selection of ORP Sensor was revised.  
Page 2 and Page 3 were revised on Specification.

**Aug. 2015/1st Edition**

Newly published

