

External Dimensions

Unit: mm
(approx. inch)

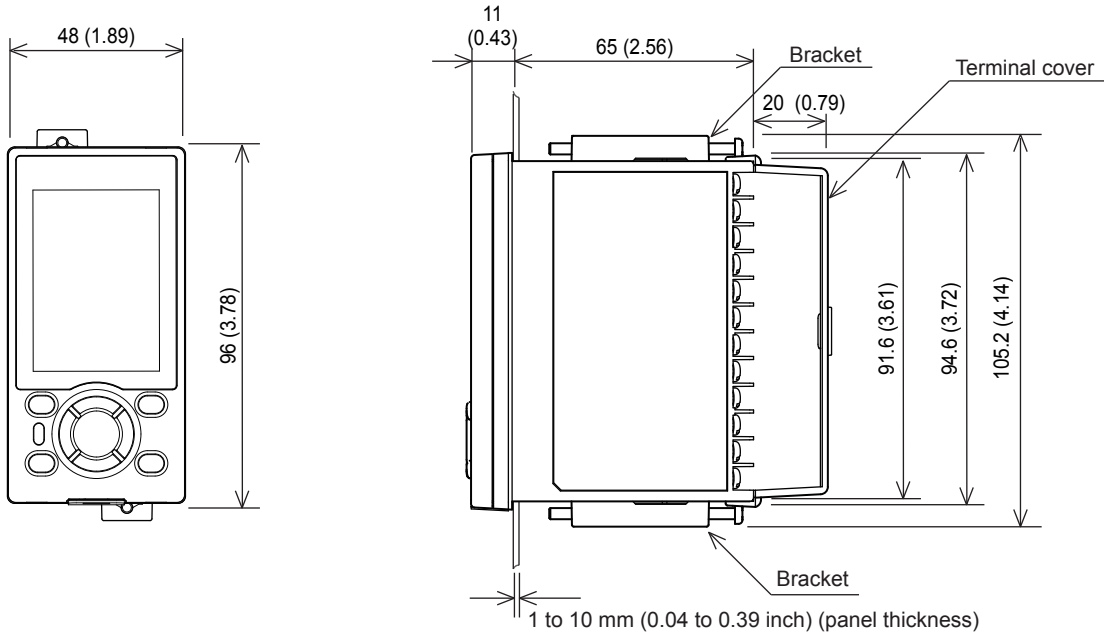

Panel Cutout Dimensions

General mounting

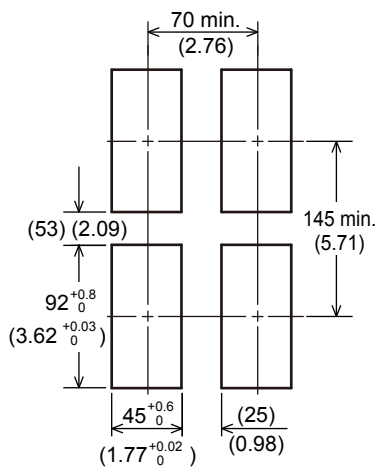

Side-by-side close mounting

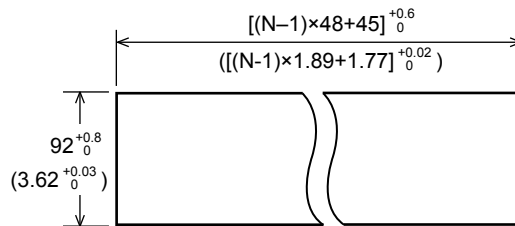

"N" stands for the number of controllers to be installed.
However, the measured value applies if N ≥ 5.

Normal tolerance: ±(value of JIS B 0401-1998 tolerance grade IT18) / 2

Terminal Wiring Diagrams

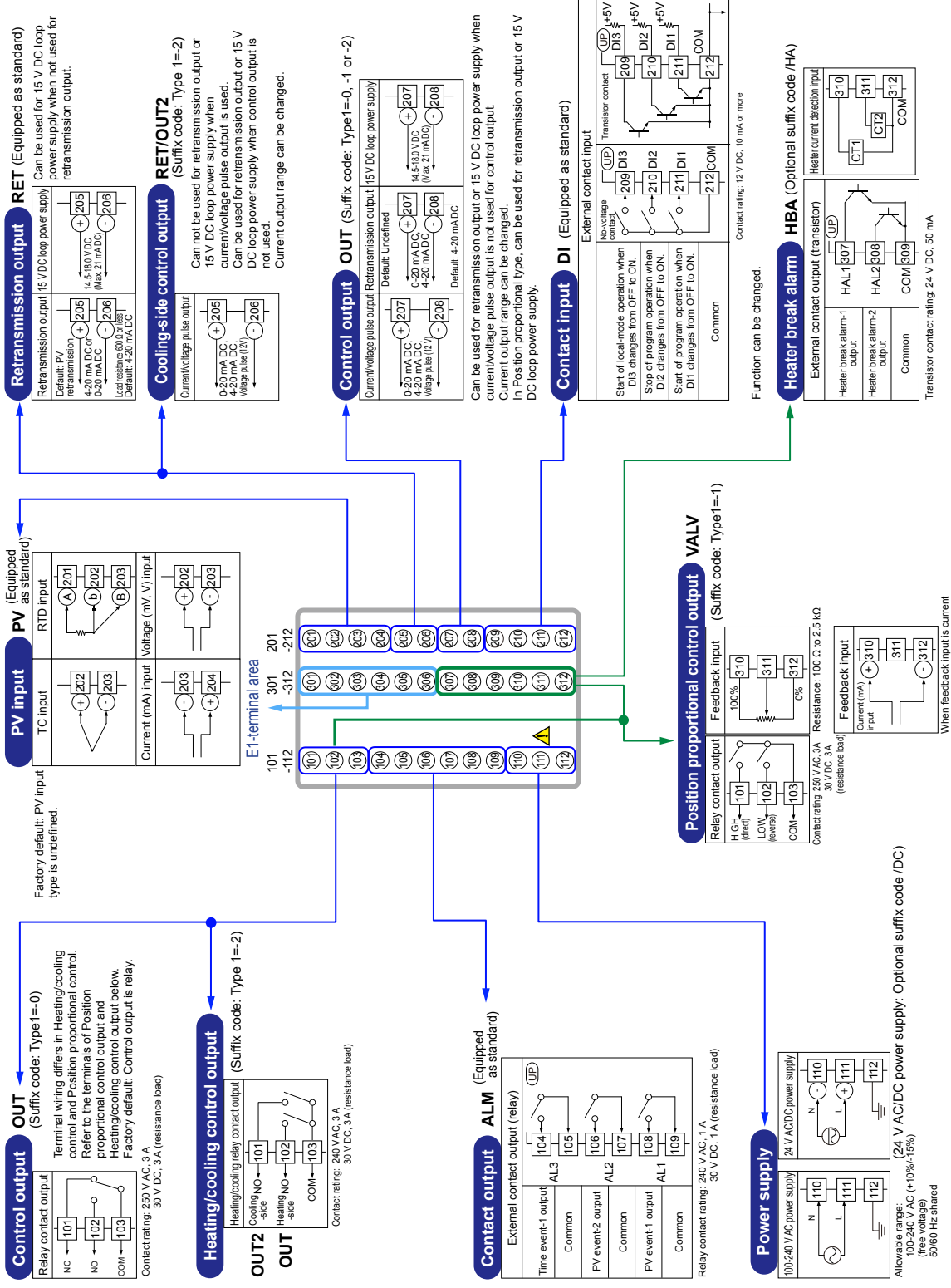

Terminal Wiring Diagrams (E1-Terminal Area)

301-312 E1端子エリア

RS-485 communication RS485

(Suffix code: Type 2=1)

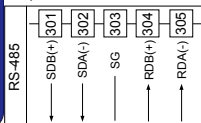

Contact input / Contact output D/I/O

(Suffix code: Type 2=2)

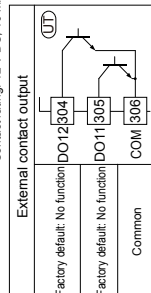
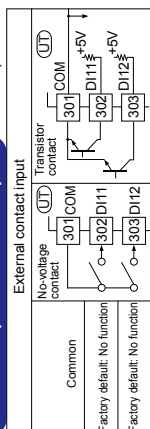

CC-Link communication (with Modbus master)

(Suffix code: Type 3=3)

If the UP is located at the end of a segment for the CC-Link communication wiring terminating resistors are separately needed. These are to be prepared by users. (110 Ω, 1 pc.)

