

Foreword

- The contents of this document are subject to change without prior notice as a result of improvements in performance or functionality.
- Copying or reproduction by any means of all or any part of the contents of this document without permission is strictly prohibited.
- Use of this document is at the users risk.

■ Overview

This is an example of wiring and settings using the UTAdvanced Quick Setting function for "tank level ON-OFF control." For more details, see the user's manual.

■ Relevant models

Standard models of the UT32A, UT35A, and UT55A with the +24 VDC sensor power supply option

■ System

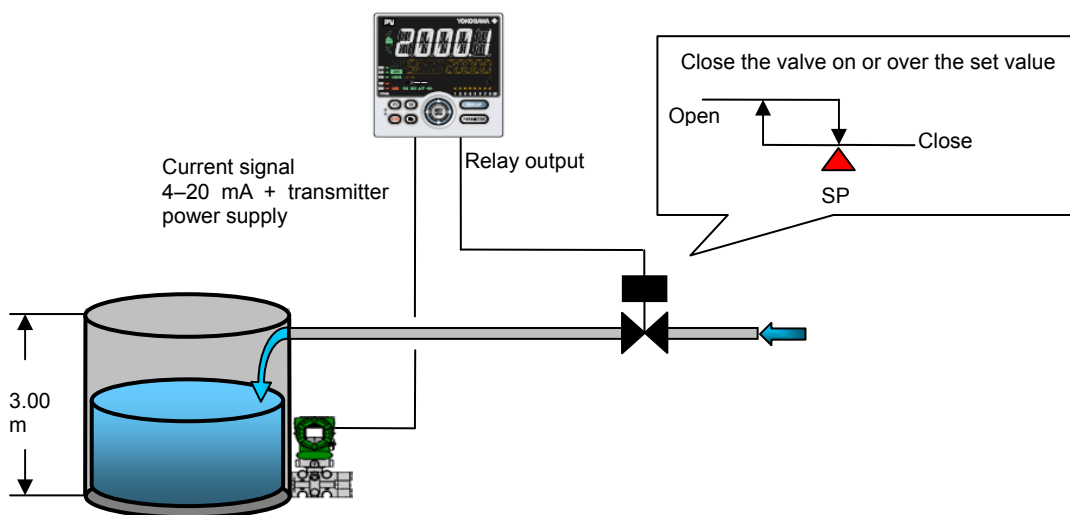

■ Wiring

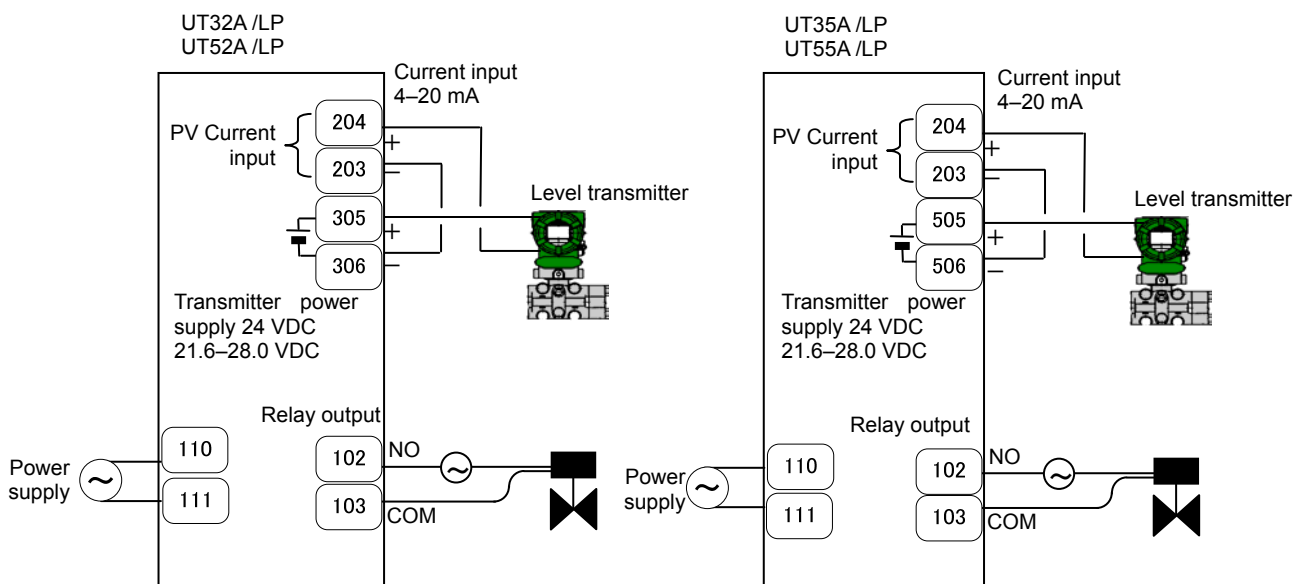

■ Settings

To set ON-OFF control, input signal (4 to 20 mA), and relay control output, set the following parameters.



- (1) Select the desired parameter with the UP or DOWN key
- (2) Press SET/ENTER (the setting value blinks)
- (3) Change the setting with the UP or DOWN key
- (4) Press SET/ENTER to set the new value (the setting value stops blinking but remains bright)

Power



Quick Setting
start



• Redoing the Quick Setting

Once functions are configured with the Quick Setting, the Quick Setting function will not appear after you restart. However, you can redo the Quick Setting by following the procedure below.

(1) Set the Quick Setting parameter QSM to ON, and re-engage power

(2) Set the PV input type parameter IN to OFF, and re-engage power

1.



Press SET/ENTER to accept the "YES" option.

Quick Setting starts

2.



First, the control type parameter CNT appears.

Set CNT (control type) to ONOF2 (initial value).

3.

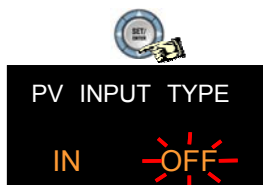

OFF is displayed for IN (the PV input type).

4.

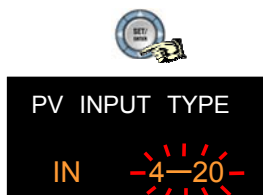

Set IN (PV input type) to current signal: 4–20.





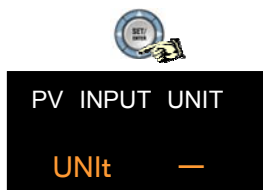





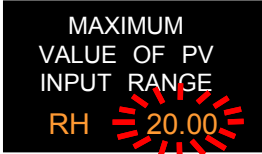

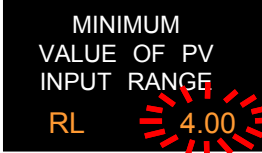

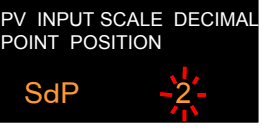
(4–20 = 4.00 to 20.00 mA)

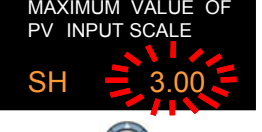
5.

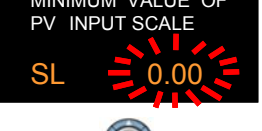

Set UNIT (PV input unit) to – (none).

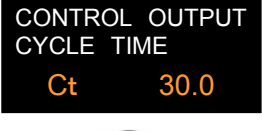
If necessary, use the unit label "m."

-
6.  Set RH (maximum value of PV input range) to 20.00 mA (initial value).

7.  Set RL (minimum value of PV input range) to 4.00 mA (initial value).

8.  Set SDP (PV input scale decimal point position) to 2.

9.  Set SH (maximum value of PV input scale) to 3.00 (3.0 m).

10.  Set SL (minimum value of PV input scale) to 0.00 (0.00 m).

11.  Set OT (output type selection) to 00.03: OUT terminal (control relay).

12.  Skip this parameter (not relevant).

13.  Finally, EXIT is displayed. Select YES and press SET/ENTER to complete the basic function setup and return to the operating screen. Or, you can select NO to continue with the Quick Setting.
-

Revision Information

Document name: Setup Procedure: UTAdvanced Quick Setting (Controlling Tank Level ON-OFF)

Document number: TI 04L01L01-05EN

First edition: December, 2011

Newly released