

FLXA2- DO Redundant System Set-up

This Tech Note is designed to assist you through the programming of the FLXA21 for redundant measurement set-up.

Initial Set-Up

Steps 1-11 are for the initial setup of a new FLXA21 with 2 DO sensor modules. If you are modifying a FLXA21 for a redundant measurement please skip to the **After Installation** section, Step 12.

1.) After the transmitter is wired and powered on, during start up the display will show the FLEXA logo.



2.) The **Quick setup** screen will appear. Using either the the  scroll key and **Enter** key; or by clicking directly on the diamond next to **YES**, select it.

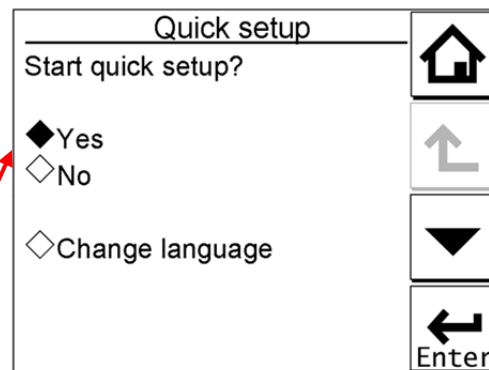

3.) Set the **Date/Time**, then select the diamond next to **NEXT**.

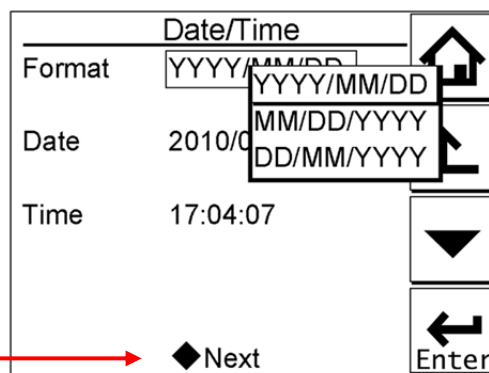

4.) In **Sensor setup**, select the appropriate **Sensor type** from the drop down menu for sensor 1, then select the diamond next to **NEXT**.

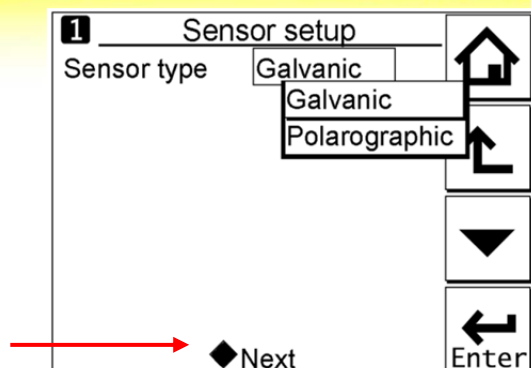

5.) In **Configure sensor**, select the appropriate **unit** of measure from the drop down menu for sensor 1, then adjust selected the appropriate sensor sensitivity. Once finished select the diamond next to **NEXT**.

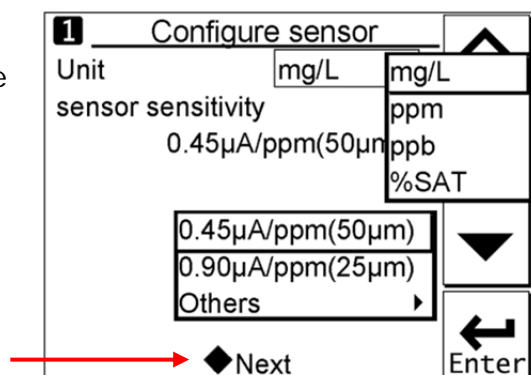

6.) In **Temperature settings**, select appropriate temperature element from the drop down menu for sensor 1, then select the diamond next to **NEXT**.

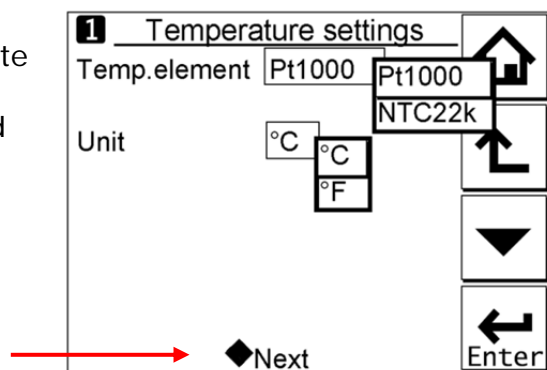

7.) In **Sensor setup**, select the appropriate **sensor type** from the drop down menu for sensor 2, then select the diamond next to **NEXT**.

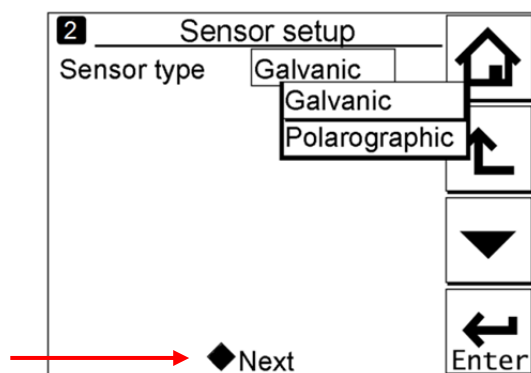

8.) In **Configure sensor**, select the appropriate **unit** of measure from the drop down menu for sensor 2, then adjust selected the appropriate sensor sensitivity. Once finished select the diamond next to **NEXT**.

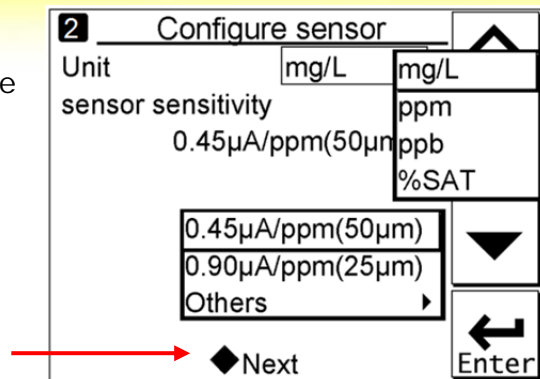

9.) In **Temperature settings**, select appropriate temperature element from the drop down menu for sensor 2, then select the diamond next to **NEXT**.

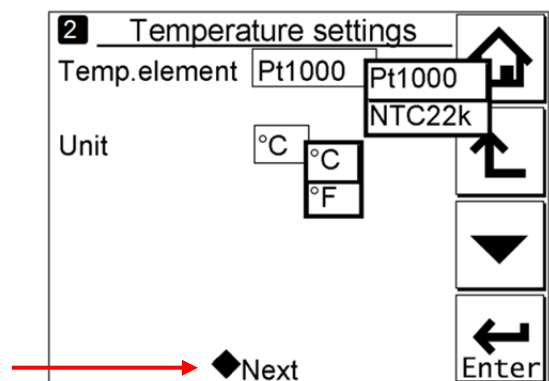

10.) In **mA(output)**, select **Redundant** for the desired process parameter for the 4-20 mA signal, and set the 0% (4mA) and 100% (20mA) values. Once complete select the diamond next to **Finish**.

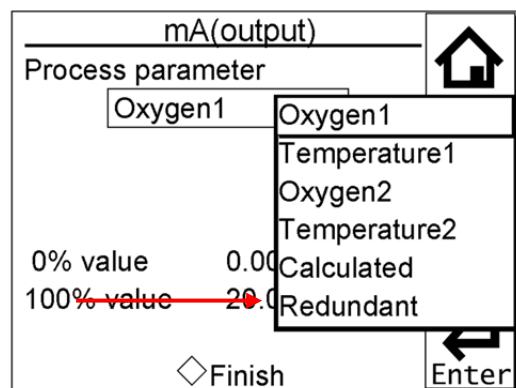

- 11.) The instrument will then bring you to the **Home** display. At this point the Home display shows you the process values for both sensor inputs. This can be confusing so it is recommended to change the display set up for Redundant System. Select sensor Input 1 (top section) information.

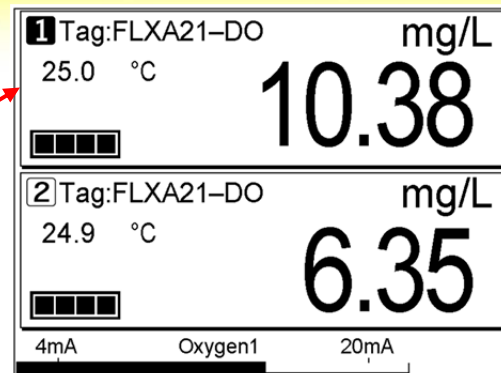

After Installation

If your instrument only has 1 sensor input module please refer to *TechNote TNA1201* for installing a second sensor module; if your instrument already has 2 sensor input modules please proceed with Step 12.

- 12.) Select sensor Input 1 (top section) information to go to Sensor 1 Main display.

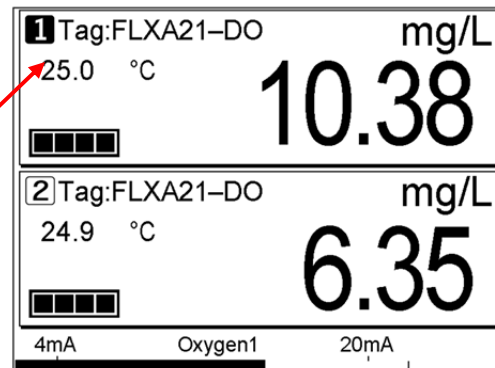

- 13.) Select Execute & setup, **Wrench** icon.

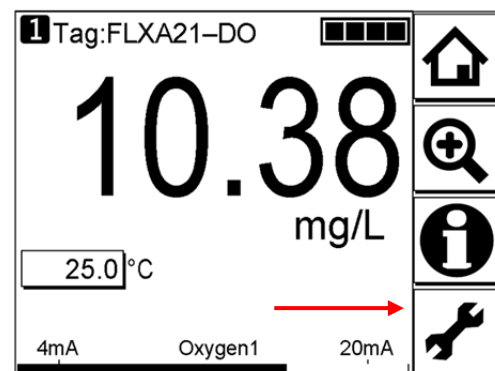

14.) Select the diamond next to **Commissioning**.

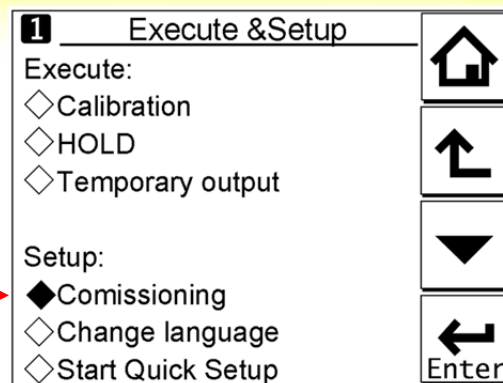

15.) Select the diamond next to **Output setup**.

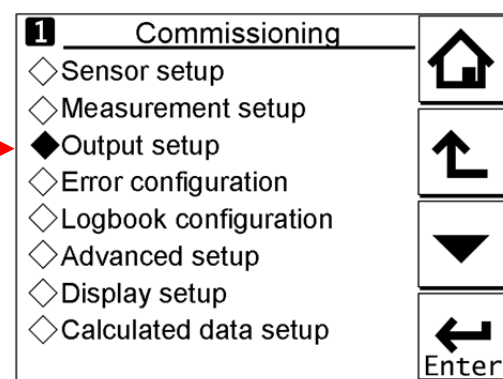

16.) Select **Output** from the drop down menu.

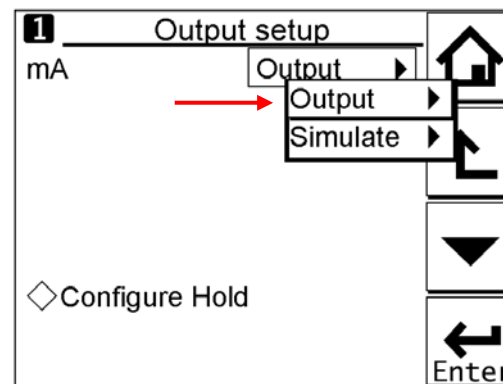

17.) Select **Redundant** from the drop down menu.

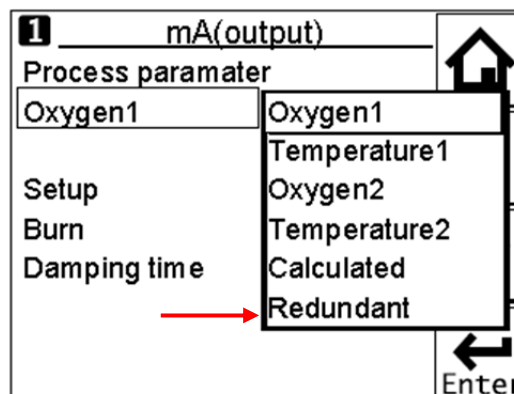

18.) Select desired mA Output Setup, Linear or Table. Most common is **Linear**.

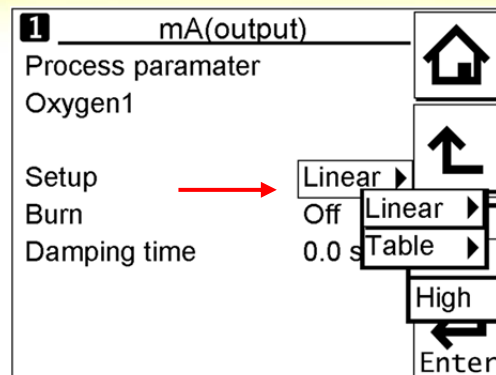

19.) Set the **0%** and the **100%** values. Then select the **Return key**,



to return to the Main display.

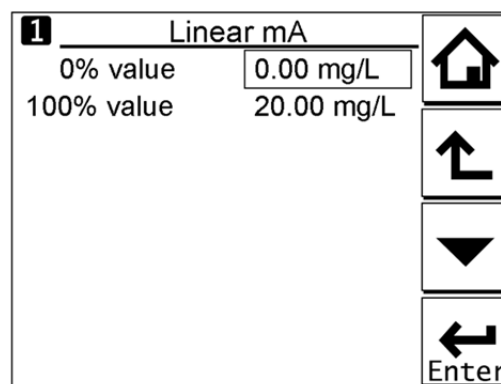

20.) Select Execute & setup, **Wrench** icon.

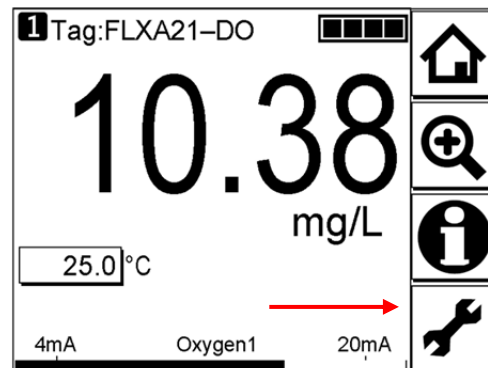

21.) Select the diamond next to **Commissioning**.

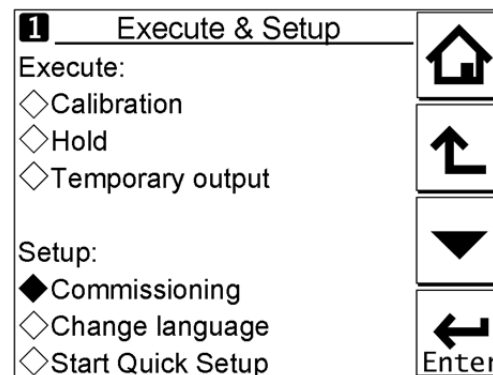

22.) Select the diamond next to **Display Setup**.

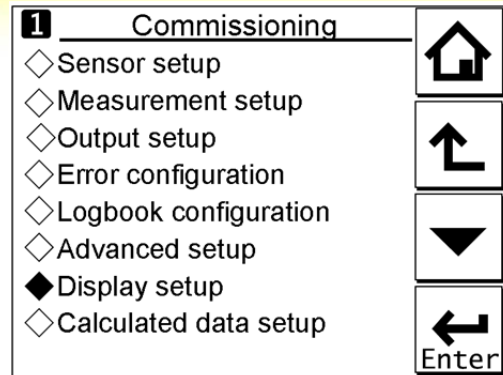

23.) Select the diamond next to **Dual display**.

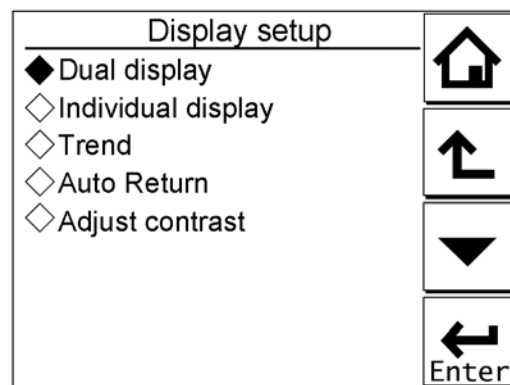

24.) Set the 1st row to **Redundant** and set the 2nd row to **DO2**, from the drop down menus.

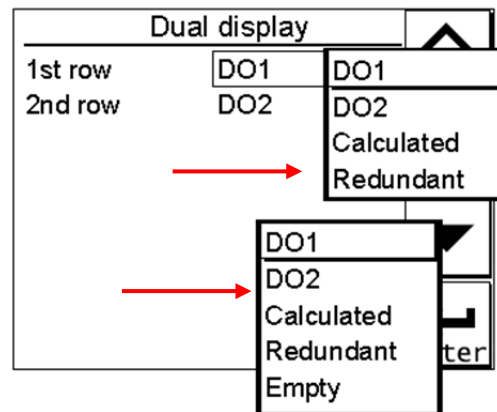

Select the **House icon**,  to return to the Home Display.

The screen to the right will appear. There are two different ways to view the Home display. This will be what most people will like the analyzer set to. In this viewing screen it allows you to see the current measurement at the same time to see if any faults are present on sensor 2. If a Failure was present the Warn/Fail

icon,  would flash in the sensor box.

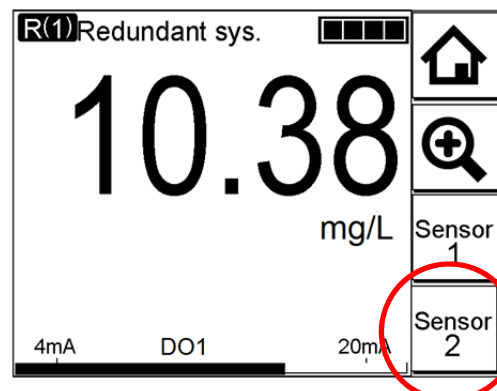

However if you select the House icon again the instrument will return to the normal view showing you the Redundant system and whatever user programmed parameter was set for 2nd row in step 24. To return back to the other Home display view, select the **Redundant system** information.

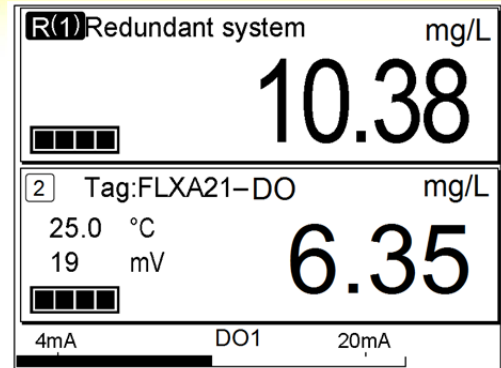

25.) When using HART communication you have to set the PV, SV, TV and FV level parameter values. Select the Sensor box, to view the Sensors Main display. Select Execute & setup, **Wrench** icon.

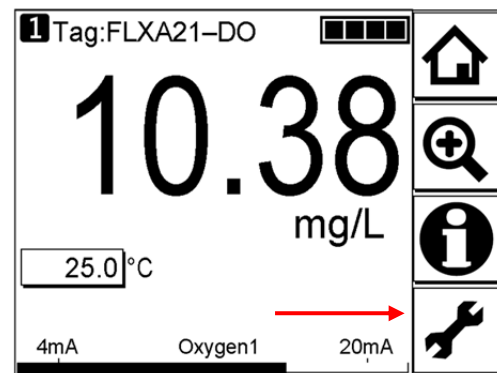

26.) Select the diamond next to **Commissioning**.

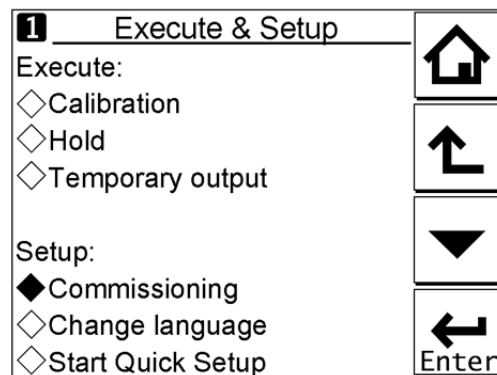

27.) Select the diamond next to **Advanced Setup**.

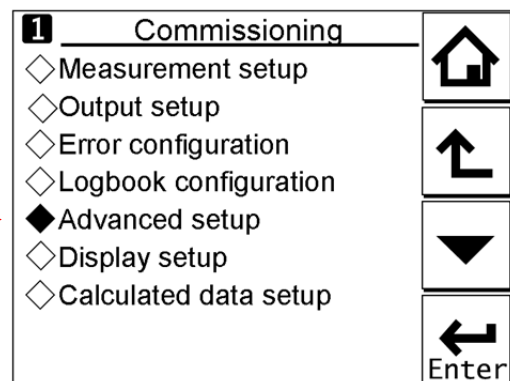

28.) Select the diamond next to **Communication**.

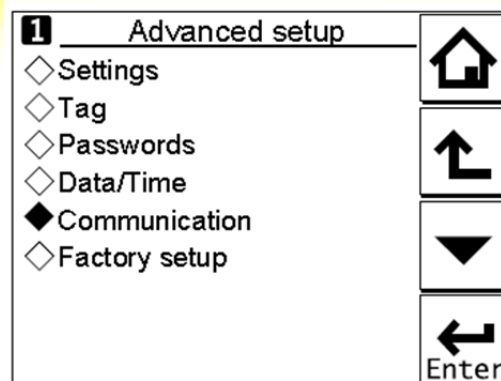

29.) Select **HART** from the drop down menu.

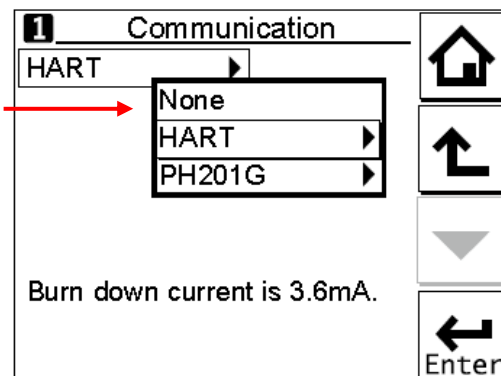

30.) Set the SV, TV and FV to the desired paramters. PV will automatically be set up for Redundant. Once complete you can select the House Icon to return to the desired Home or Main display.

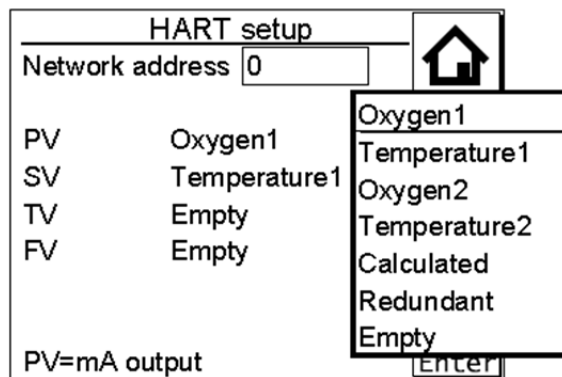

Appendix: It is important to note that when sensor input 1 fails and the instrument automatically switches to sensor input 2 as the primary function, the only way to change the unit back is to manually reset the mA output. Follow the steps below:

1.) Once you are on Sensor input 1 Main display Select Execute & setup, **Wrench** icon.

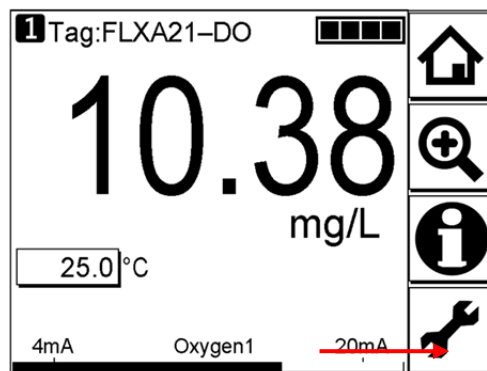

2.) Select the diamond next to **Commissioning**.

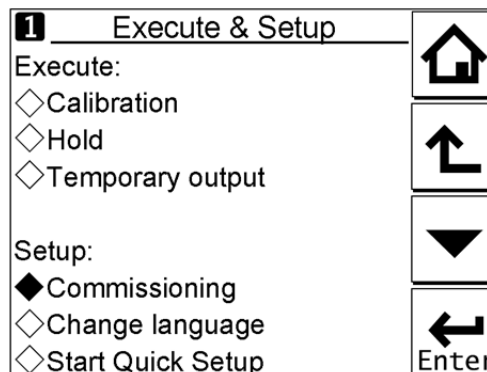

3.) Select the diamond next to **Output setup**.

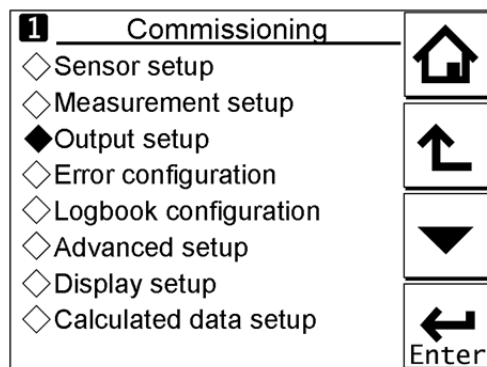

4.) Select the diamond Next to **Reset Redundant**.

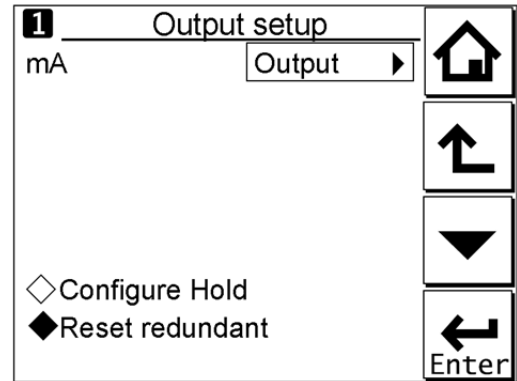

5.) Select the diamond next to **YES** to confirm the reset. Once complete the instrument will then again be using sensor input 1 as the primary mA output.

